

INDUSTRIAL WEIGHING SOLUTION™

CI-2001 A/B

Weighing Indicator

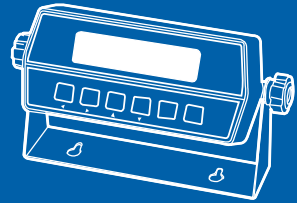

www.globalcas.com

OWNER'S MANUAL

CAS



CONTENTS

PRECAUTIONS.....	6
FEATURES	6
TECHNICAL SPECIFICATION.....	7
DIMENSIONS	9
FRONT PANEL (CI-2001A).....	10
FRONT PANEL (CI-2001B).....	13
REAR PANEL.....	16
INSTALLATION.....	17
TEST MODE.....	18
CALIBRATION MODE	21
SET MODE.....	25
SERIAL INTERFACE.....	30
ERROR MESSAGE.....	34

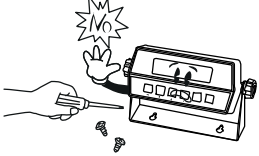
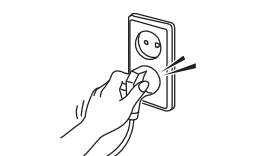
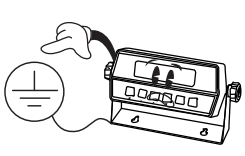
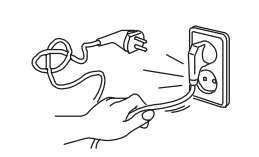
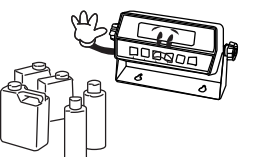
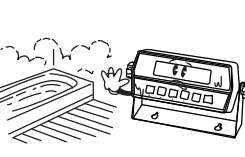
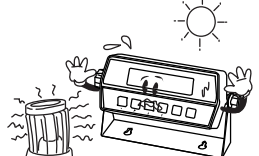
⚠ Warning

<p>Never disassemble, repair or retrofit the product. It might exclude the product from the quality assurance and cause the damage to devices, electric shock or fire.</p>	<p>Ensure the power plug to be fully inserted to prevent shaking. Any instable connection might cause electric sparks to set fire.</p>	<p>Ensure the grounding of the product. Poor grounding might cause failure or electric shock upon electric leak.</p>
		
<p>Do not damage, process, excessively jerk, bend or twist the power cord. It might damage the power cord to cause fire or electric shock.</p>	<p>Keep any combustible spray or fire source away. It might cause fire.</p>	<p>Do not spray water to the outside of the product or use it in any humid place. It might deteriorate the insulation of electric parts that can cause the electric shock, fire risk or weighing errors.</p>
		
<p>Do not place the product to the direct sunlight or near any hot object like a heater. It might cause fire.</p>		
		

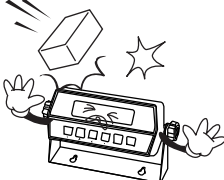
 **Attention**

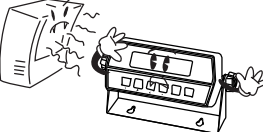
<p>Check the weighing error anytime for the accurate weighing. Any use out of the allowed tolerance for the careless use or other causes might not ensure the accurate weighing. Customer Service : 080-022-0022</p>	<p>Avoid any sudden shock to the product. It might damage the product to fail the accurate weighing</p>	<p>Find a proper place to attach the rubber pad at the bottom of the indicator, which was shipped together.</p>
		
<p>Do not use the product at a place with sudden temperature changes or severe vibrations. It might cause the weighing error or failure.</p>	<p>Do not install the produce at a place with the excessive electromagnetic wave. It might cause the wrong weighing.</p>	
		

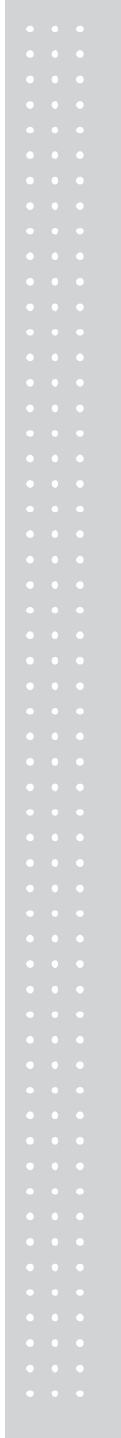

PRECAUTIONS

Thank you very much for purchasing CAS International Indicator.

This produce is characterized by the excellent performance and luxurious features through strict examinations, as well as elaboration for each part under our strict quality control.

CAS Indicator (CI series) is a product with rich functions and various external interfaces, which is designed to comply well with special requirements in a variety of industrial fields under strong and beautiful designs in appearance.

In addition, it is designed for the user-friendly programs for the easier use of indicator by any user with the built-in message display functions to help users understand the product.

Please use the product right and sufficiently utilize functions of CI-2000 series as you read this manual thoroughly before using CI-2000 series.

FEATURES

(1) Features

- Appropriate for weight and measurement system.
- Easy operation and various options.
- Simple Full Digital Calibration.
(SPACTM : Single pass automatic span calibration)
- WATCHDOG circuitry (System restoration).
- Weight Back-up (Power on Zero).
- Wall mount type (CI-2001A/B) - Standard
- Panel mount type (CI-2001A/B(P)) - Optional

(2) Main Function

- Various specification of weight conversion speed.
(Digital filter function)
- Various printer connection.(RS232 Serial printer - optional)
- Users can set the desirous max. weight and a division freely.
- Self hardware test.
Prompt A/S is available for test of each part of circuit by module is possible.

TECHNICAL SPECIFICATION

■ Analog Part

LoadCell Excitation Voltage	DC 5V, Up to 4 x 350 Ω load cells
Zero adjust range	0.05 mV ~ 5 mV
Input Sensitivity	2 μ V/D (NTEP, OIML, KS)
	0.5 μ V/D (Non NTEP, OIML, KS)
System Linearity	0.01% F.S.
A/D internal resolution	1 / 200,000
A/D external resolution	1 / 5,000 (NTEP, OIML, KS)
	1 / 30,000 (Non NTEP, OIML)
A/D conversion speed	10times/sec

■ Digital Part

Span calibration	Full Digital Calibration : SPACTM (Single pass automatic span calibration)	
Display	CI-2001A	LED (6 digit)
Size of letter	CI-2001B	LCD (5 digit)
Display below zero	CI-2001A	14 mm (Height)
Additional Symbols	CI-2001B	25 mm (Height)
AC Adapter	“-” minus sign	
Power Consumption	CI-2001A	Zero, Tare, Gross, Net, Stable, lb, kg
Operating Temperature	CI-2001B	Zero, Net, Stable, lb, kg
Overall Dimensions	AC 110V/220V (DC 6V ~ 12V, 850mA)	
Weight	CI-2001A	10 W
Span calibration	CI-2001B	1 W
Display	-10°C to +40°C	
Size of letter	85mm x 186mm x 58mm	
Display below zero	0.5 kg	

■ Option

Standard	Serial Interface : RS-232
Option-1	Serial Interface : RS-422/485
Option-2	Panel Mount Bracket
Option-3	Inner Clock (only CI-2001B)

DIMENSIONS

■ WALL-MOUNT TYPE(CI-2001A/B)-STANDARD

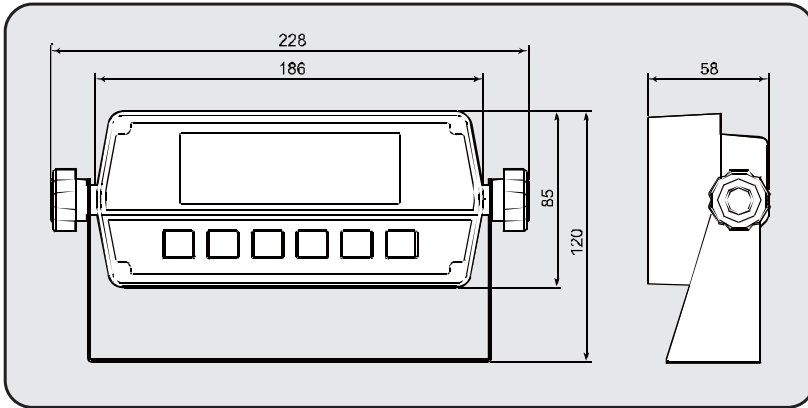

■ PANNEL-MOUNT TYPE (CI-2001A/B(P))

(Cutting Size : 166mm x 76mm)

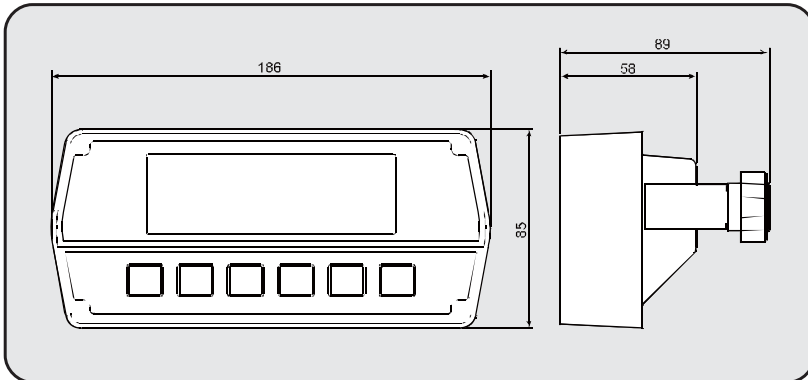

FRONT PANEL (CI-2001A)

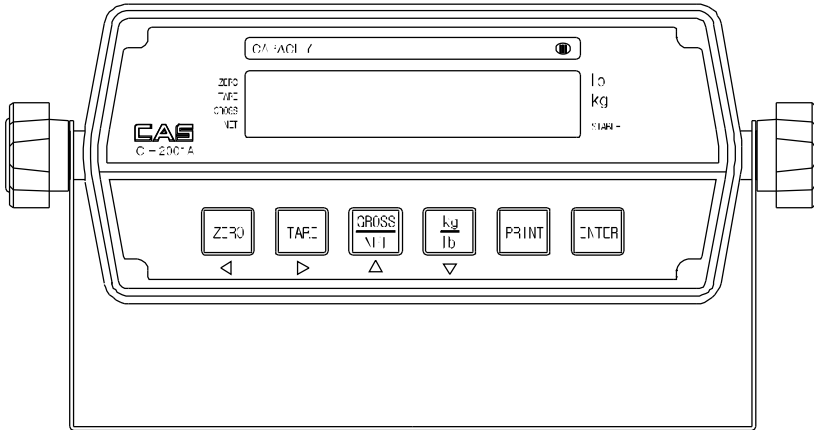

1. Display LAMP (■)

lb Lamp	ON when the weight unit is pound [lb]
kg Lamp	ON when the weight unit is kilogram [kg]
STABLE Lamp	ON when the weight is stable.
TARE Lamp	ON when the tare weight is stored.
GROSS Lamp	ON when the current weight is GROSS weight.
NET Lamp	ON when the current weight is NET weight.
ZERO Lamp	ON when the current weight is 0 kg(0 lb).

2. KEY PART

▲, ◀	Available keys instead of numeric keys.
▲	Change the set value Increase the first place value to 1
◀	Change the digit of the set value Move to the left by 1 place USAGE : Input the numeral value in TEST, CAL, SET mode.
ZERO Key	Return the display to 0
TARE Key	Use container in weighing. Current weight is memorized as tare weight. If you press TARE key in unload condition, Tare setting is released.
GROSS/NET KEY	Display gross and net weight by turn. GROSS lamp on - gross weight NET lamp on - net weight In case tare weight is REGISTERED, tare and item's total weight is G. weight and only item's weight is N. weight.
Kg / lb KEY	Toggles between lb and kg units.
PRINT KEY	PRINT Key
ENTER KEY	<ul style="list-style-type: none"> ▣ Total Print KEY. → In case of F09 : 1 ▣ Hold KEY. → In case of F09 : 2 ▣ In CALIBRATION, TEST, SET mode. : Store current condition and exit.



3. How to enter TEST mode

- Turn on the Power while pressing the "PRINT" key and SET mode starts.

4. How to enter SET mode

- Turn on the Power while pressing the "ENTER" key and SET mode starts.

5. How to enter CAL mode

- Turn on the power while pressing the CAL switch on the rear panel of the indicator and CAL mode starts.

FRONT PANEL (CI-2001B)

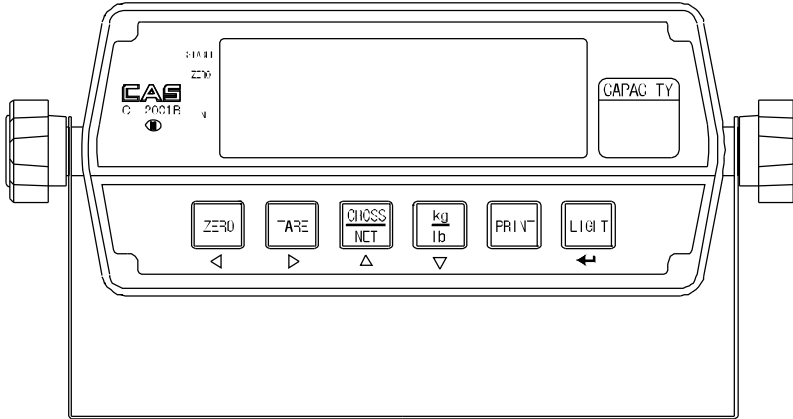

1. Display LAMP (■)

Lb	ON when the weight unit is pound [lb]
kg	ON when the weight unit is kilogram [kg]
○	ON when the weight is stable.
ZERO	ON when the current weight is 0 kg(0 lb).
NET	ON when the current weight is NET weight.

2. KEY PART

▲, ◀	Available keys instead of numeric keys.
▲	Change the set value Increase the first place value to 1
◀	Change the digit of the set value Move to the left by 1 place USAGE : Input the numeral value in TEST, CAL, SET mode.
ZERO Key	Return the display to 0
TARE Key	Use container in weighing. Current weight is memorized as tare weight. If you press TARE key in unload condition, Tare setting is released.
GROSS/NET KEY	Display gross and net weight by turn. GROSS lamp on - gross weight NET lamp on - net weight In case tare weight is REGISTERED, tare and item's total weight is G. weight and only item's weight is N. weight.
* KEY	▣ Total Print KEY. → In case of F09 : 1 ▣ Hold KEY. → In case of F09 : 2
PRINT KEY	PRINT Key - Total Print key (by pressing "PRINT" key more than 3 second.)
ENTER KEY	▣ In CALIBRATION, TEST, SET mode. : Store current condition and exit.

3. How to enter TEST mode

- └ Turn on the Power while pressing the "PRINT" key and SET mode starts.

4. How to enter SET mode

- └ Turn on the Power while pressing the "LIGHT" key and SET mode starts.

5. How to enter CAL mode

- └ Turn on the power while pressing the CAL switch on the rear panel of the indicator and CAL mode starts.

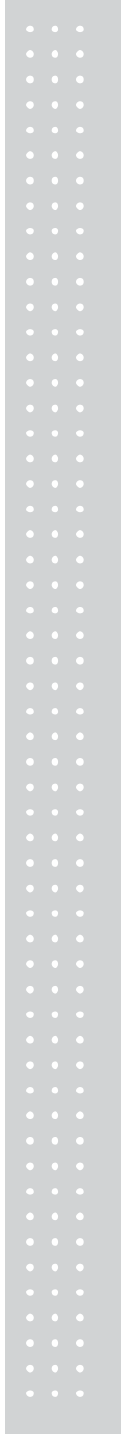

REAR PANEL

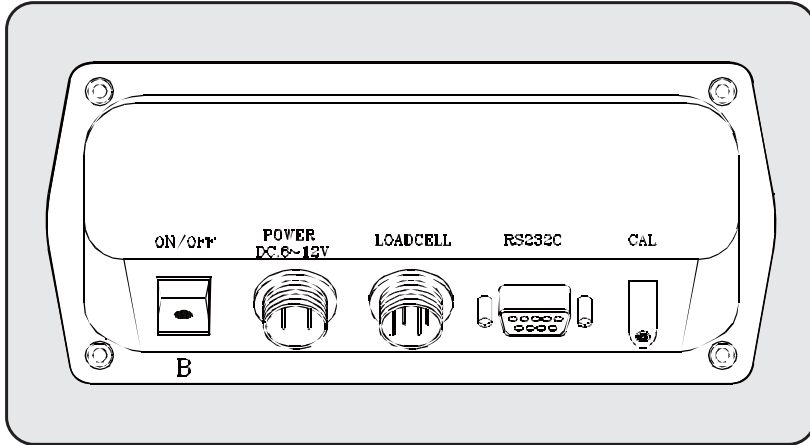

■ Rear Panel Description

RS-232C PORT	Serial interface port.(Computer, printer ...)
LOADCELL	Port for connecting load cell.
POWER	Port for DC power. (DC 12V adaptor are available)
CAL S/W	Used in calibration starts.
ON/OFF	Power ON/OFF switch.

INSTALLATION

■ LoadCell Connection

Connect load cell connector to load cell port which is in the backside of indicator.

► Connection Method

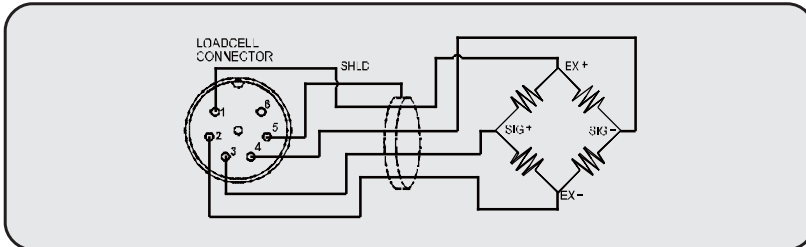

Ref. Each L/C manufacturer's or model's wire color could be different. In that case, please note the following diagram.

► Resolution to loadcell output rate

Loadcell Sense Voltage for 5V Excitation Voltage	Recommended resolution
2 mV	1/1,000 (Max)
4 mV	1/2,000 (Max)
10 mV	1/5,000 (Max)

► Manufacturer's wire colors

Connector Cooperation	No.1 (EX+)	No.2 (EX-)	No.3 (SIG+)	No.4 (SIG-)	No.5 (Shield)
CAS	RED	WHITE	GREEN	BLUE	SHIELD
KYOWA	RED	BLACK	GREEN	WHITE	SHIELD
INTERFACE	RED	BLACK	GREEN	WHITE	SHIELD
P.T	RED	BLACK	GREEN	WHITE	SHIELD
BLS	GREEN	BLACK	WHITE	RED	YELLOW
SHOWA	RED	BLUE	WHITE	BLACK	SHIELD
SHINKOH	RED	BLACK	GREEN	WHITE	SHIELD
TMI	RED	WHITE	GREEN	BLUE	YELLOW
TML	RED	BLACK	WHITE	GREEN	SHIELD
TFAC	RED	BLUE	WHITE	BLACK	YELLOW
HUNTLEIGH	GREEN	BLACK	RED	WHITE	SHIELD

TEST MODE

1. HOW TO ENTER

Turn on the power while pressing the "PRINT" key and TEST menu starts.
(CI-2001A/B kg/lb Version)

Turn on the power while pressing the "*" key and TEST menu starts.
(CI-2001A/B kg only Version)

2. AVAILABLE KEYS

▲	Increase the first place set value to 1
◀	Move to the left by 1 place of the set value.
*	Initialize Setting value.
ENTER	Move into next menu. (CI-2001A)
LIGHT	Move into next menu. (CI-2001B)

3. TEST MENU (TEST 1 - TEST 5)

TEST 1	KEY TEST
TEST 2	DISPLAY TEST
TEST 3	Loadcell test and A/D conversion TEST
TEST 4	Serial interface test (RS-232)
TEST 5	Printer test

TEST 1

■ FUNCTION : KEY TEST

KEY	DISPLAY	DESCRIPTION
ENTER(LIGHT) : Next Menu Other Keys : Perform TEST		TEST 1 condition. Press the key to be test and the no. and code of the key is displayed.

CI-2001A KEY CODE		CI-2001B KEY CODE	
KEY	CODE	KEY	CODE
ZERO	1	ZERO	1
TARE	2	TARE	2
G/N	3	G/N	3
PRINT	4	PRINT	4
*	5	*	5
ENTER	6	LIGHT	6

TEST 2

■ FUNCTION : DISPLAY TEST

KEY	DISPLAY	DESCRIPTION
		TEST 2 condition TEST 2 is performed automatically

REF 1. Program is automatically shifted to menu selection mode after completing

TEST 3

■ FUNCTION : A/D Converter TEST (L/C TEST)

KEY	DISPLAY	DESCRIPTION
ENTER(LIGHT) : Next Menu Other Keys : Perform TEST		TEST 3 condition Display digital value of current weight. This value means converted digital value

REF 1. Check whether digital value is changing.

If the digital value is fixed or zero is displayed, please check the connection of the load cell.

TEST 4

■ FUNCTION : RS-232 TEST With Computer.

KEY	DISPLAY	DESCRIPTION
ZERO : Transmit '0' TARE : Transmit '1'	TEST 4	TEST 4 condition
G/N : Transmit '2' kg/lb: Transmit '3'	0 - - - 0	Wait for transmission and reception
* : Transmit '4'	0 - - - 1	Receive: 1, Transmit: none
LIGHT: Next menu	13 - - 0 1	Receive: 1, Transmit: 13

REF 1. Do this test after the connection between serial port of computer and serial port of indicator.

REF 2. Send no. 1 in computer keyboard and check if indicator receives no. 1

Send no. 1 in indicator keyboard and check if computer receives no. 1

REF 3. Do this test after baud rate is specified in SET mode(F11).

TEST 5

■ FUNCTION : PRINT TEST

KEY	DISPLAY	DESCRIPTION
ENTER(LIGHT) :	TEST 5	TEST 5 condition
Next Menu	GOOD	No error in printer
Other Keys :		Check printer connector
Perform TEST	ERR 06	

REF 1. Please confirm that F02(SET MODE) value is set as 1 before a test.

REF 2. "GOOD" message is displayed if the printer connection and specification is done correctly. If not, "ERROR 06" message is displayed.

REF 3. The test output format of printer is like follows.

T E S T O K

CALIBRATION MODE

1. HOW TO ENTER

Turn on the power while pressing the CAL switch on the rear panel of the indicator and CAL mode starts.

2. AVAILABLE KEYS

▲	Increase the first place set value to 1
◀	Move to the left by 1 place of the set value.
PRINT (kg/lb version) ◀*? (kg only version))	Initial('0') of the set value.
ENTER	Move into next menu. (CI-2001A)
LIGHT	Move into next menu. (CI-2001B)



3. CALIBRATION MENU (CAL 1 ~ CAL 5)

CAL 1	Maximum Capacity
CAL 2	Minimum Division
CAL 3	Setting Weight
CAL 4	Zero Calibration
CAL 5	Span Calibration

CAL 1

■ FUNCTION: SET Maximum Capacity

Range → 1 ~ 999,999 kg (CI-2001A)
1 ~ 99,999 kg (CI-2001B)



KEY	DISPLAY	DESCRIPTION
▲: Increase of no. ◀: Shift of digit ENTER(LIGHT) : Store and move into next menu	  	CAL 1 condition 100 kg/lb 10000 kg/lb

REF 1. The maximum capacity means the maximum weight that scale can measure.

CAL 2

■ FUNCTION: SET Minimum Division

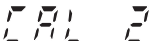
Range → 0.0005 ~ 100 kg/lb

KEY	DISPLAY	DESCRIPTION
▲: Input the next division. ENTER(LIGHT) : Store and move into next menu	  	CAL 2 condition 1 kg 0.01 kg

REF 1. The minimum division means the value of one division.



REF 2. External resolution is obtained by division the min. division by the maximum capacity. Set the resolution to be within 1/30,000.

CAL 3

■ FUNCTION: Setting Weight In Span CALIBRATION

Range → 1 ~ 999,999 kg (CI-2001A)

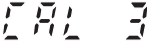
1 ~ 99,999 kg (CI-2001B)

KEY	DISPLAY	DESCRIPTION
▲: Increase of no. ◀: Shift of digit ENTER(LIGHT) : Store and move into next menu	  	CAL 3 condition 100 kg 10000 kg

REF 1. The weight shall be within the range of 10 % ~100 % of maximum weight.

REF 2. If the Setting Weight is under the 10% of the Maximum Capacity,



Error message ("ERR 22") will occur.

REF 3. If the Setting Weight over the Maximum Capacity,

Error message ("ERR 23") will occur.

CAL 4

■ FUNCTION: Zero Calibration

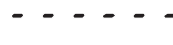
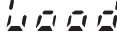
KEY	DISPLAY	DESCRIPTION
ENTER(LIGHT) : Zero calibration and Move into next menu.	   	CAL 4 condition Unload the tray and press ENTER Under zero calibration Zero calibration is completed.

REF 1. If Zero calibration is done without any error, GOOD message is displayed and program moves into CAL 5 automatically.

REF 2. If the "ZERO" key is press, only Zero Calibration is completed and program moves SAVE & EXIT mode. Press ENTER Key.

CAL 5

■ FUNCTION: Span Calibration

KEY	DISPLAY	DESCRIPTION
ENTER(LIGHT) :	CAL 5	CAL 5 condition
Span calibration and Move into next menu.	Load	Load the weight which was set in CAL 3 and press LIGHT.
	-----	Under span calibration. Span calibration is completed.
	Good	Press ENTER(LIGHT) key. (Save & Exit CAL Mode)

REF 1. If Span calibration is done without any error, GOOD message is displayed

The weight of setting weight is displayed on LCD screen.

Check the weight.

REF 2. If the span is low, Error message (ERR 24) is displayed.

Calibrate with lower resolution.

4. SEALING METHOD

Install the seal on the wire loop as shown in below Figure.

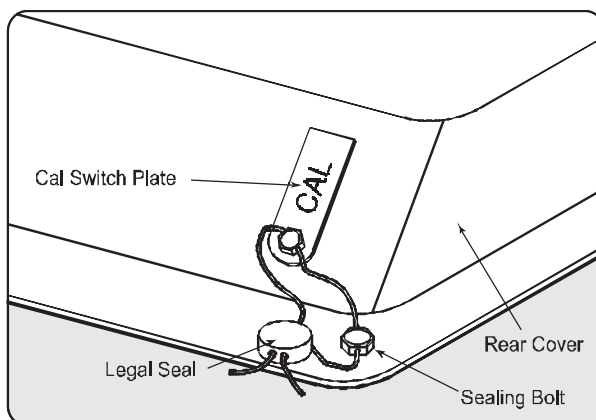

SET MODE

1. HOW TO ENTER

Turn on the power while pressing the "LIGHT" key and SET menu starts.

2. AVAILABLE KEYS & CONVERTING METHOD

▲	Increase the first place set value to 1
◀	Move to the left by 1 place of the set value.
ENTER	Move into next menu. (CI-2001A)
LIGHT	Move into next menu. (CI-2001B)

3. SET VALUE CONVERSION MENU (F01 - F19)

F01	Zero Key Operating Range (Only CI-2001B)
F02	Serial Port (RS232) Usage
F03	Automatic zero tracking compensation
F04	Digital Filter
F07	Weight Back-up (Power-on Actual Weight)
F08	"PRINT" Key Usage (Only CI-2001A)
F09	"LIGHT" Key Usage
F10	Device ID
F11	Designation of Serial Interface Baud rate
F12	Designation of Serial Interface output mode
F13	Set HOLD type
F14	Select of clock option
F17	Set Line Feed
F18	Set Model Select (Only CI-2001B)
F19	Set Auto Print (Only CI-2001B)

Zero key Operating Range		
F01	Set Range (0~99)	
	2	The 'Zero' Key is operated within 2% of the maximum weight.
	10	The 'Zero' Key is operated within 10% of the maximum weight.

Serial Port (RS232) Usage		
F02	0	Connection with computer and sub-display (CD-3000A)
	1	Connection with Serial printer

Automatic Zero Tracking			
F03	0	None Automatic zero	
	1	1 : 0.5 Digit	Autozero tracking will automatically bring the display back to "0" when there are small deviations.
	~	.	
9	9 : 4.5 Digit		

Digital Filter			
F04	1	1 : Less Vibration	Adjust the set value according to the condition.
	~	.	
	9	9: MuchVibration	

Weight Backup		
F07	0	Weight back-up is off (Power on Zero)
	1	Weight back-up is on

"PRINT" Key Usage (Only CI-2001A)		
F08	0	No Use
	1	Total Print Key

“ENTER” Key Usage (Only CI-2001A)		
F09	0	No Use
	1	Total Print Key
	2	HOLD Key

“*” Key Usage (Only CI-2001B)		
F09	0	No Use
	1	Total Print Key
	2	HOLD Key

Device ID			
F10	00	00 : Device ID '0'	It is used the ID of indicator when system is connected.
	~	.	
	99	99 : Device ID '99'	

Baud Rate		
F11	0	600 bps
	1	1200 bps
	2	2400 bps
	3	4800 bps
	4	9600 bps
	5	19200 bps

Output Mode			
F12	0	No data output	
	1	Stream Mode	
	2	Transmit only in stable condition	
	3	Transmit when data is required → Request signal : device ID (F10 : Device ID) → In case F10 : 1, Send Hex Value 01h in Computer)	(In case F10 : 1, Send Hex Value 01h in Computer)

Set Hold type		
F13	0	Average hold : Compute the average weight of oscillating weights.
	1	Peak hold : Compute the maximum weight among oscillating weights.
	2	Sampling Hold :

Select Option Clock (only CI-2001B)		
F14	0	Not use Clock
	1	use Clock

Change Date/Time (Ex. 2014/07/26 13:10:01)			
▲ : Increase of no.	Display	Meaning	Ex
	C1 14	Year	14
◀ : Shift of digit	C2 07	Month	07
	C3 26	Day	26
ENTER (LIGHT) : Store and move into next menu	C4 13	Hour	13
	C5 10	Minute	10
	C6 01	Second	01

Line Feed			
F17	0	0 : No Line Feed	Set Line Feed
	~ 9	9 : 9 Line Feed	

Set Model Select (Only CI-2001B)		
F18	0	Set Model "CI-2001B"
	1	Set Model "CPS"
	2	Set Model "WCS"

Set Auto Print (Only CI-2001B)		
F19	0	No Use Auto Print
	1	Use Auto Print

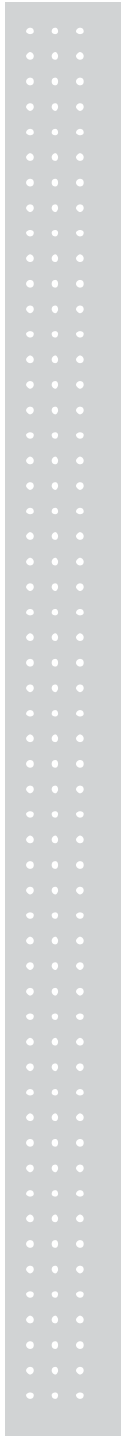

SERIAL INTERFACE

Standard	RS-232C Serial Interface
-----------------	---------------------------------

◆ RS-232C Port Connection

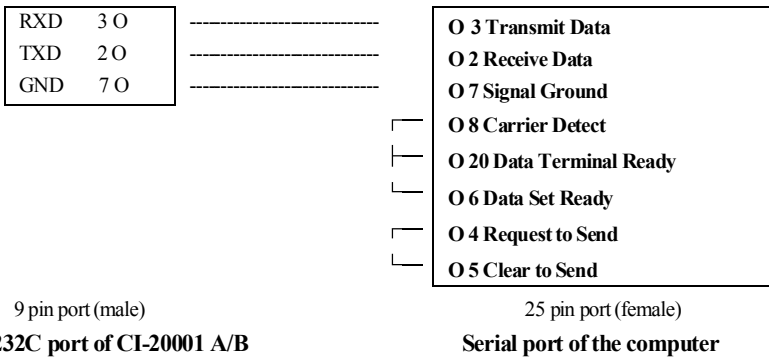
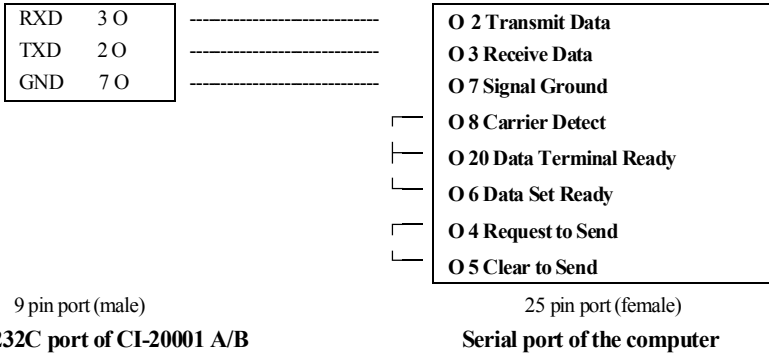

◆ Sub-Display Connection

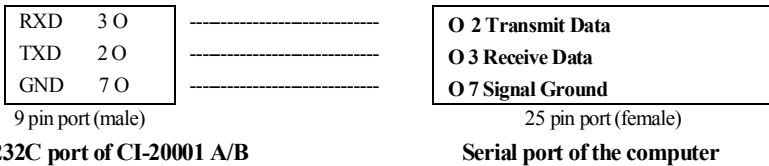

◆ Data Format

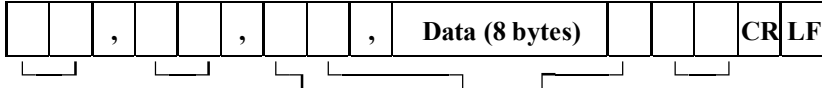

US (Unstable) GS (Gross weight) Device ID Lamp Status byte Empty Unit (kg/t)
 ST (Stable) NT (Net weight)
 OL (Overload)

■ Device ID

Transmit 1 byte device ID so that the receiver can receive data selectively which indicator send.

(Device ID is selected in F22)

■ Weight Data(8 byte)

1. 13.5 kg : '1', '3', '5', '0', '0', '0', '0', '0'

2. 135 kg : '1', '3', '5', '0', '0', '0', '0', '0'

3.- 135 kg : '1', '3', '5', '0', '0', '0', '0', '0'

Each ASCII code of Weight transmitted by 8 byte. (Ex, '0' : 0x20)

◆ Simple Interface Program

*** GWBASIC Language

```
10 OPEN "COM1:9600,N,8,1" As #1
```

```
20 IF LOC(1) = 0 THEN 60
```

```
30 A$ = INPUT$(1,1)
```

```
40 PRINT A$ ; " ";
```

```
50 GOTO 20
```

```
60 B$=INKEY$ : IF B$="" THEN 20
```

```
70 PRINT B$ ; " ";
```

```
80 PRINT #1,B$;
```

```
90 GOTO 20
```

```

*** C Language
#include <bios.h>
#include <conio.h>
#define COM1 0
#define DATA_READY 0x100
#define TRUE 1
#define FALSE 0
#define SETTINGS 0xE3
int main(void)
{
    int in, out, status, DONE = FALSE;
    bioscom(0, SETTINGS, COM1);
    cprintf("... BIOSCOM [ESC] to exit ...\n");
    while (!DONE)
    {
        status = bioscom(3, 0, COM1);
        if (status & DATA_READY)
            if ((out = bioscom(2, 0, COM1) & 0x7F) != 0)
                putchar(out);
            if (kbhit())
            {
                if ((in = getch()) == '\x1B')
                    DONE = TRUE;
                bioscom(1, in, COM1);
            }
    }
    return 0;
}

```

◆ CP-7000 Series Printer Connection

RXD	3	O	-----
TXD	2	O	-----
GND	7	O	-----

9 pin port (male)

RS-232C port of CI-20001 A/B

O 3	Transmit Data
O 2	Receive Data
O 14	Signal Ground

15 pin port (female)

CP-7000 Series Printer Port

◆ **ND Series Serial Printer Connection**

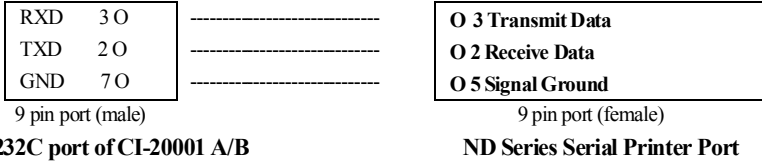

Option	RS-422/485 Serial Interface
---------------	------------------------------------

- ▣ Transmit mode : Same as RS-232C interface COM1
- ▣ Data Format : Same as RS-232C interface COM1

◆ **Connecting method of RS-422 Port**

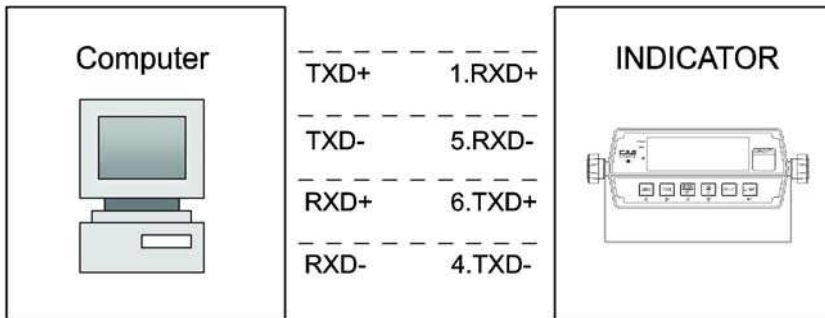

◆ **Connecting method of RS-485 Port**

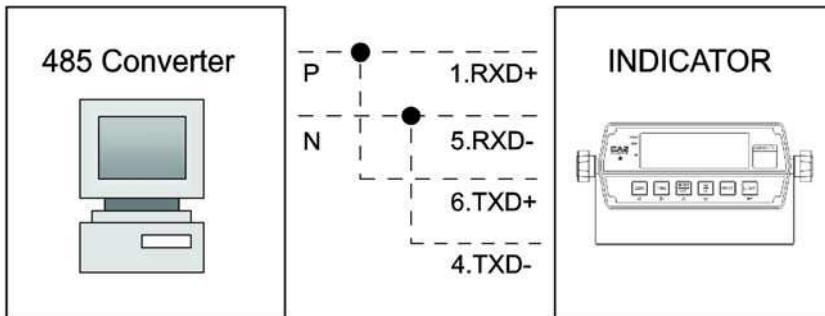

ERROR MESSAGE

(1) ERRORS IN WEIGHTING MODE

Err 02

■ Reason

Load cell connection failure or error in A/D conversion part.

🔧 Trouble shooting

Check the load cell connector to see if the polarity of signal is reversed.

Err 06

■ Reason

Error in printer connection

🔧 Trouble shooting

Check with printer connector

If there is no problem with printer and printer connector, please request A/S to head office.

Err 08

■ Reason

The ZERO key or TARE key is adjusted not to be operated under the unstable condition.

🔧 Trouble shooting

Press Zero or Tare key in stable condition

Err 09

■ Reason

Current weight deviates from zero range.

🔧 Trouble shooting

Press the ZERO key within 10% of the maximum capacity.

Err 10

■ Reason

Tare weight exceeds the maximum capacity of the scale.

☞ Trouble shooting

Set the tare to be smaller than the maximum capacity.

Otherwise the maximum capacity is reset to be larger than the tare to be set in the calibration menu, and reset the calibration using weight.

Err 13

■ Reason

The zero range deviates from the set range.

☞ Trouble shooting

Confirm that there is nothing on the weighing platform.

If nothing exist, do calibration in CAL mode.

Over

■ Reason

The weight on platform is too heavy to be measured.

☞ Trouble shooting

Do not load the item exceeds the maximum tolerance.

If the load cell is damaged, the load cell should be replace.

(2) ERRORS IN CALIBRATION MODE

Err 21

■ Reason

The resolution is set to be exceeded the limit 1/10,000.

☞ Trouble shooting

Lower the resolution.

The resolution = allowed weight/one division

Modify the allowed weight in CAL1 or modify the division in CAL2 so that the resolution should be below 1/10,000.

Err 22

■ Reason

The weight for span calibration is set to be lower than 10 % of the maximum capacity of the scale.

☞ Trouble shooting

Set the weight for span calibration in CAL3 to be more than 10% of the maximum capacity.

Err 23

■ Reason

The weight for span calibration is set to be exceeded 100 % of the maximum capacity of the scale.

☞ Trouble shooting

Set the weight for span calibration to be within the maximum capacity of the scale in CAL 1.

Err 24

■ Reason

The load cell output is too small at SPAN calibration.

☞ Trouble shooting

Setting of current resolution is not possible due to the error in load cell. Proceed calibration again with less resolution.

Loadcell Sense Voltage for 5V Excitation Voltage	Recommended Resolution
2 mV	1/1,000
4 mV	1/2,000
10 mV	1/5,000

Err 25

■ Reason

The load cell output is too large at SPAN calibration.

☞ Trouble shooting

Setting of current resolution is not possible due to the error in load cell. Proceed calibration again with less resolution.

Err 26

■ Reason

The load cell output is too large at ZERO calibration.

☞ Trouble shooting

Check whether the platform empty.

Proceed calibration again after checking in A/D TEST mode.

MEMO

MEMO

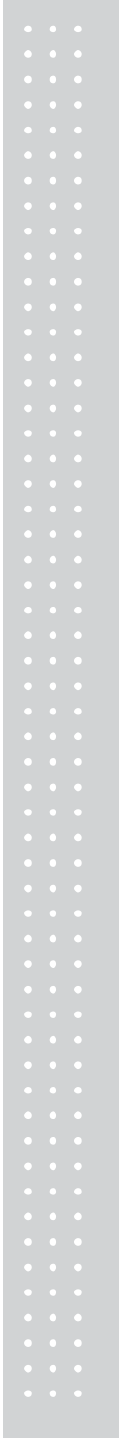

MEMO

CI-2001 A/B

Weighing Indicator



CAS BLDG., #1315, YANGJAE-DAERO,

GANGDONG-GU, SEOUL, KOREA

TEL_ 82 2 2225 3500

FAX_ 82 2 475 4668

www.globalcas.com