

CI-600A SERIES

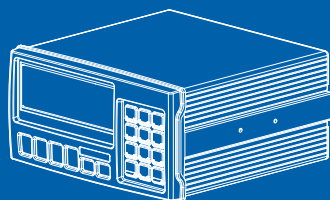

Weighing Indicator







Cautions for Your Safety

Please comply with 'Cautions for Your Safety', which will lead you to use the product safely and properly to prevent any dangerous situations.



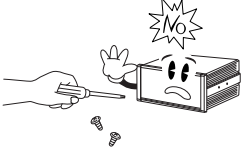

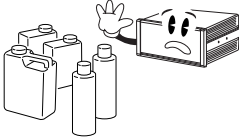
- Cautions are divided into 'Warning' and 'Alert', which mean as follows.
- Keep this manual in a place where product users can find out, after finish reading it.

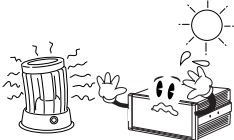
 Warning
'Warning' means a great possibility led to the death or heavy injury when instructions are violated.
 Attention
'Alert' means a great possibility led to the injury or material damage when instructions are violated.

! Warning

<p>Never disassemble, repair or retrofit the product. It might exclude the product from the quality assurance and cause the damage to devices, electric shock or fire.</p>	<p>Ensure the power plug to be fully inserted to prevent shaking. Any instable connection might cause electric sparks to set fire.</p>	<p>Ensure the grounding of the product. Poor grounding might cause failure or electric shock upon electric leak.</p>
		
<p>Do not damage, process, excessively jerk, bend or twist the power cord. It might damage the power cord to cause fire or electric shock.</p>	<p>Keep any combustible spray or fire source away. It might cause fire.</p>	<p>Do not spray water to the outside of the product or use it in any humid place. It might deteriorate the insulation of electric parts that can cause the electric shock, fire risk or weighing errors.</p>
		
<p>Do not place the product to the direct sunlight or near any hot object like a heater. It might cause fire.</p>		
		

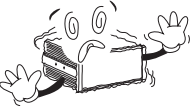
! Attention

<p>Check the weighing error anytime for the accurate weighing. Any use out of the allowed tolerance for the careless use or other causes might not ensure the accurate weighing. Customer Service : 080-022-0022</p>	<p>Avoid any sudden shock to the product. It might damage the product to fail the accurate weighing.</p>	<p>Find a proper place to attach the rubber pad at the bottom of the indicator, which was shipped together.</p>
		
<p>Do not use the product at a place with sudden temperature changes or severe vibrations. It might cause the weighing error or failure.</p>	<p>Do not install the produce at a place with the excessive electromagnetic wave. It might cause the wrong weighing.</p>	
		

Our Dealers : CAS feels that each of its valued customers should get the best service available. Whether it's the initial installation of our product, maintenance/repair work, or simply answering questions about our products, CAS Corporation and all of its Authorized Dealers are highly trained to assist you with any need regarding CAS products.

Contents

1. Features	9
1-1. Features	9
1-2. Major Functions	9
1-3. Digital Loadcell Interface	10
1-4. Digital and Display	10
1-5. General Specifications	11
1-6. Communication and Option	11
2. Specifications in Appearance	12
2-1. External Dimension	12
2-2. Front Panel Descriptions	12
2-3. Keyboard	14
2-4. Rear Panel Descriptions	17
3. Installation & Connection	18
3-1. Loadcell Connection	18
4. Weight Setup(Calibration) Mode	19
4-1. Weight Setup(Calibration) Menu	20
4-2. How to Seal the Indicator(Sealing)	27
5. Weight Mode	28
5-1. Zero function	28
5-2. Tare function	29
5-3. Net Weight / Gross Weight Selection	30
5-4. Item Number Change	31
5-5. Subtotal Print	31
5-6. Total Print	32
5-7. Selection and Change of Article Information	33
5-8. How to Change Item Number	33
5-9. Change in Tare Weight	34
6. Test Mode	35

7. Set Mode	40
7-1. How to Enter the Set Mode	40
7-2. General Functions.....	43
7-3. Communication and Function Setting	49
7-4. Print Function Setting.....	54
7-5. Option Setting.....	59
7-6. Hardware Set Function.....	60
8. RS-232C Interface in Detail	62
8-1. RS-232C Port Connection	62
8-2. How to Connect an Auxiliary Display	63
8-3. How to Connect a Label Printer(DLP)	63
8-4. RS-422 & 485 Serial Communications	64
9. Serial Data Information	65
9-1. CAS 22Bytes Format	65
9-2. CAS 10Bytes	65
9-3. AND 18Bytes	65
9-4. CAS 22Bytes with relay status Format.....	66
10. Appendix	67
11. Error Message	75
11-1. Error Message from the Weight Setup Mode	75
11-2. Error Message from the Weighing Mode	76

Preface

Thank you very much for purchasing CAS International Indicator.

This produce is characterized by the excellent performance and luxurious features through strict examinations, as well as elaboration for each part under our strict quality control.

CAS Indicator (CI-series) is a product with rich functions and various external interfaces, which is designed to comply well with special requirements in a variety of industrial fields under strong and beautiful designs in appearance.

In addition, it is designed for the user-friendly programs for the easier use of indicator by any user with the built-in message display functions to help users understand the product.

Please use the product right and sufficiently utilize functions of CI-600 series as you read this manual thoroughly before using CI-600 series.

1. Features

1-1. Features

- High speed, High accuracy
- High speed micro processor adoption
- A/D conversion speed : Maximum 200 times/sed
- Appropriate for weight and measurement system
- Easy operation and various options.
- Simple and prompt Full Digital Calibration (SPAC™: Single pass automatic span Calibration)
- RFI/EMI screened
- Watch Dog circuitry (System restoration)
- Weight Back-up (Weight memory at sudden power failure)

1-2. Main Functions

- Store date, time and calculated data at sudden power failure.
- Various specification on weight conversion speed. (Digital filter function)
- Various printer connection. (RS-232C Serial printer)
- Tare weight setting with keys.
- Storage of measured times.
- Set Point input & highest, lowest limit input.
- External input 4 relay.(CI-605)
- External output 6 relay.(CI-605)
- Users can set the desirous max. weight and a division freely.
- Control various external equipment by inner external input/output. (option)
- Print date and time by inner clock.
- Self hardware Test.
- Prompt A/S is available for Test of each part of circuit by module is possible.

1-3. Analog and A/D Conversion

Applied voltage for load cell	DC 5V (350Ω maximum 8 possible connections)
Zeroing range	0 ~ 2mV/V
Input sensitivity	0.5 uV / D (OIML,)Ntep, KS
	0.3 uV / D (Non OIML,)Ntep, KS
Non-straightness	0.01% Full Scale
A/D internal resolution	1 / 520,000
A/D external resolution	1 / 10,000 (NTEP,)OIML, KS
	1 / 20,000 (Non NTEP,)OIML, KS (Possible with the use of sufficient output at 2mV/V L/C)
A/D conversion speed	Maximum 200 rounds/second
Weight setup	Full Digital Calibration : SPACTM (Automatic weight setup at once)

1-4. Digital and Display

Span Calibration	Full Digital Calibration : SPACTM (Single automatic span Calibration)
Display	4.3" Full Graphic LCD
Sign for status	ZERO, TARE, NET,GROSS, STABLE, HOLD, RX,TX,USB,UNIT(kg, lb, ton)
Division	×1, ×2, ×5, ×10, ×20, ×50
Tare Subtraction	Full capacity
Display Below Zero	"-"Minus

1-5. General Specifications

Power	AC 85~264V, 50~60 Hz (20W)
Product Size	192(W) x 199(D) x 96 (H)
Temperature Range	-10℃ ~ 40℃
Fuse Capacity	T2A L250V
Product Weight	Approx. 1.8 kg

1-6. Option Specification

Option - 1	Analog V-out (0 ~10V) or I-out (4~20mA)
Option - 2	Relay module Type1
Option - 3	BCD Out
Option - 4	Relay module Type2
Option - 5	ZigBee or Bluetooth
Option - 6	RS232 to USB
Option - 7	RS232 or RS485
Option - 8	Ethernet Card

Note 1. Ensure to affirm before purchasing the product since there may be a limitation for the option module that can be used depending on the program version.

[CI-605A]









Display Information







1. 6Digits, Decimal point, sign
2. Unit : kg, lb, ton
3. Message Display : Key input, Error message..
4. Short cut key with function name
5. Set data SP1~4 (CI-605)
6. External input status (CI-605)
7. External output status (CI-605)

2-3. Keyboard











Function Key

	<p>* It sets the weight display near zero point to 0. (A range of 2%, 5%, 10%, 20% and 100% can be selected.)</p>
	<p>* Use it to weigh with the tare. * The current weight is memorized as the tare by pressing the key. * Press the key when the load tray is empty to release the tare.</p>
	<p>* Use it change to item number or name</p>
	<p>* Use it enter to menu mode.</p>
	<p>* Some functions can be defined to the needs. * Use it for the manual print. (default) (The function set at M2120 in the Set Mode will be operated.)</p>
	<p>* Some functions can be defined to the needs. * Use it to fix the shaking weight(default) (The function set at M2121 in the Set Mode will be operated.)</p>
	<p>* Some functions can be defined to the needs. * Use it to tare canceling. (default) (The function set at M2122 in the Set Mode will be operated.)</p>

Editor Key

	<ul style="list-style-type: none"> * It enters 0~9 in the input numeric mode * It enters A~Z , symbol in the input alphabet mode
	<ul style="list-style-type: none"> * Use it to cursor up-down
	<ul style="list-style-type: none"> * Use it to cursor left-right * Use it to page up-down
	<ul style="list-style-type: none"> * Use it to erase prvious character
	<ul style="list-style-type: none"> * Use it to change input symbol
	<ul style="list-style-type: none"> * Use it to correct any wrong input while entering data. * Use it to enter a decimal point (.) in the calibration mode
	<ul style="list-style-type: none"> * Use it to save input value.

Multi Function key

Numbers + 	* Use it to change Item number.
Numbers + 	* Use it to key tare function * If the tare is known, enter it using the numeric keys. (If the remaining value occurs when the input value is divided into the minimum unit, the value is rounded and entered.)
 + 	* If F1 is set it for the manual print. You can use this function * Use it to print the subtotal print (The base setting of F1 key is the Print key.) Delete the total print data after printing will be progressed by setting menu.
 + 	* If F1 is set it for the manual print. You can use this function * Use it to print the grandtotal print (The base setting of F1 key is the Print key.) Delete the total print data after printing will be progressed by setting menu.
 + 	* Use it to clear subtotal data
 + 	* Use it to clear grandtotal data

2-4. Rear Panel Descriptions

CI-601A, CI-605A

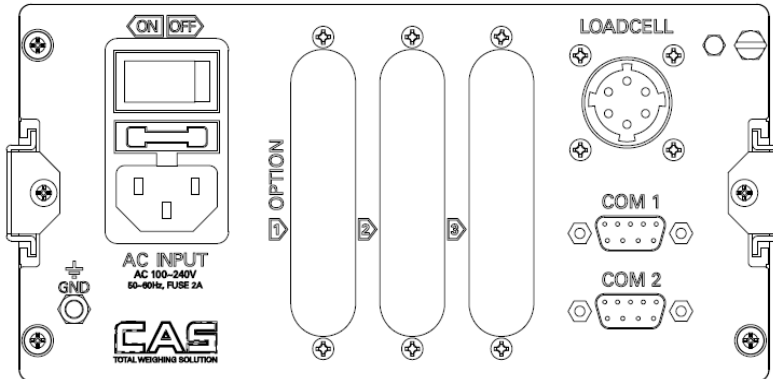

- LOAD CELL : Port for connection. 4Wires, 6Wires Loadcell
- COM 1 : Serial Interface Com Port (Option - RS485)
- COM 2 : Serial Interface Com Port
- OPTION : When Option in Use, please connect.
- AC INPUT : AC 100 ~ 240V(50/60Hz) ara available.
FUSE - T2AL250V

3. Installation & Connection

3-1. Loadcell Connection

Connect the load cell connector to the load cell port which is in the backside of the indicator.

* Connection method

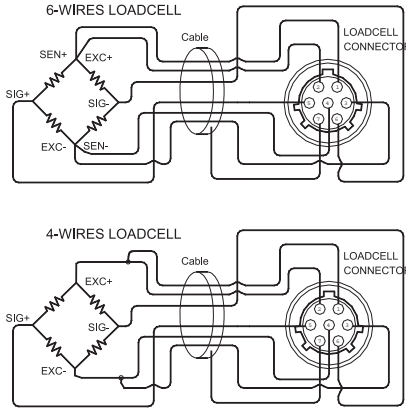

Pin	Function	Color
1	EXC+	Red
2	SEN+	Brown
3	EXC-	White
4	SEN-	Black
5	SIG+	Green
6	SIG-	Blue
7	SHIELD	Shield

Note 1. In case of 4 wires load cell, connect EX+ with SEN+, and connect EX- with SEN-.

Note 2. Wire color can be different depending on the load cell's manufacturer or it's model.

* Relationship between the load cell output and input sensitivity.

The input sensitivity of this product is maximum 0.2uV/digit or more.

The following equation should be satisfied upon the system design.

$$0.2\mu\text{V} \leq \frac{\text{Applied voltage of load cell} \times \text{Output voltage of load cell} \times \text{Value of a division}}{\text{Rated capacity of load cell} \times \text{Number of load cell}}$$

Example 1) Number of load cell: 4 ea
 Rated capacity of load cell: 500 Kg
 Rated output of load cell: 2mV/V
 Value of a division: 0.10 Kg
 Applied voltage of load cell: 5V (= 10,000 mV)

According to the equation $\rightarrow (10000 \text{ mV} * 2\text{mV} * 0.1\text{Kg}) / (500\text{Kg} * 4) = 1 \geq 0.2\mu\text{V}$
 As the calculated value is greater than 0.2uV, this weight system design has no problem.

Note 3. It can check the mV/V value in the testmode3

4. Weight Setup (Calibration) Mode

What is the weight setup?

It refers to the calibration to set the displayed value to the actual weight in displaying weights.

How to Access to the Weight Setup Mode

Remove the blot on the rear panel and connect both of CAL pin(check picture below)

And turn on the power supply and push the **3** **GHI** key same time, you can access to weight setup mode

Press the **F3** **Home** key in the weight setup mode to return to weighing mode.

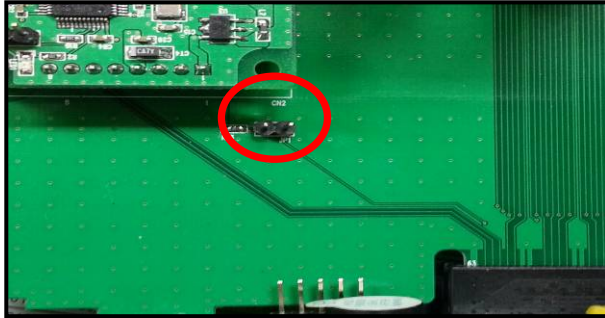

4-1. Weight Setup(Calibration) Menu (CAL1 – CAL7)

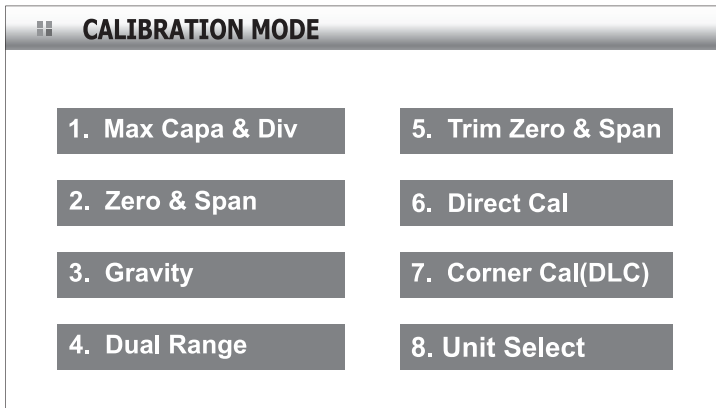

CAL 1: Maximum capacity & Division

CAL 2: Zero & Span Calibration

CAL 3: Gravity adjustment

CAL 4: Setting Dual range

CAL 5: Trimming Zero & Span





CAL 6: Direct Calibration

CAL 7: Corner Adjustment

CAL 8: Unit Select

Note 1. When you need to corner adjust, you must be corner adjustment function before the weight calibration

CAL 1 (Setting of Maximum Weight and Minimum Division)

Setting Method	Display Part
<p>1. Using numeric keys  ~ </p> <p>Enter maximum weight.</p> <p> = Set,  =Cancel</p> <p>2. Enter minimum division.</p> <p>Push  when entering a decimal point</p>	<div style="display: flex; justify-content: space-around; align-items: center; margin-bottom: 20px;"> <div style="background-color: #333; color: white; padding: 10px 20px; border-radius: 5px;">Max Capa</div> <div style="background-color: #ccc; padding: 10px 20px; border-radius: 5px;">10</div> </div> <div style="display: flex; justify-content: space-around; align-items: center;"> <div style="background-color: #333; color: white; padding: 10px 20px; border-radius: 5px;">Division</div> <div style="background-color: #ccc; padding: 10px 20px; border-radius: 5px;">0.002</div> </div>

Note 1. If [Cancel] key is pushed with a decimal point set, weight & division settings are terminated .

Note 2. Minimum division refers to the value of 1 division.

CAL 2 (Zero and Span Setting)

CAL 2-1 (Set Multi Step and Zero)

Setting Method	Display Part
Using numeric keys 0 9 Set the multi step, CLEAR =Cancel Set the zero after affirming stability of AD value.	<div style="display: flex; flex-direction: column; align-items: center;"> <div style="display: flex; justify-content: space-around; width: 100%;"> <div style="background-color: #333; color: white; padding: 10px; border-radius: 5px;">MultiCal</div> <div style="background-color: #ccc; padding: 10px; border-radius: 5px; width: 40px; text-align: center;">1</div> </div> <div style="display: flex; justify-content: space-around; width: 100%; margin-top: 10px;"> <div style="background-color: #333; color: white; padding: 10px; border-radius: 5px;">ZeroAD</div> <div style="background-color: #ccc; padding: 10px; border-radius: 5px; width: 40px; text-align: center;">5680</div> </div> </div>

Note 1: Multi setting section consists of steps 1~5.

A function used to compensate for the load cell output by setting multiple points in some section when actual curve of the load cell is not a straight line as shown below

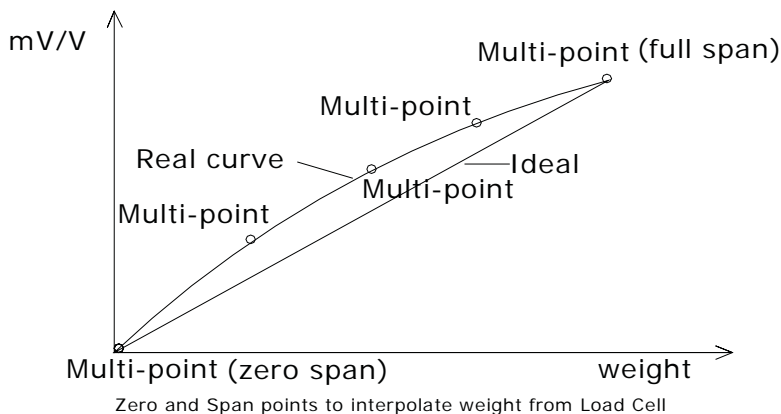

Note 1. When the zero setting is completed without any error, it moves to the weight setting without a key being pushed.

Note 2. When only span setting is desired with the zero set, it moves to

CAL 2-2 by pushing **ITEM**  key after multi setting.

CAL 2-2(Enter Weight and Span Settings)

Load_1	1.000	Span_AD1	15532
Load_2	2.000	Span_AD2	35461
Load_3	5.000	Span_AD3	54650
Load_4	8.000	Span_AD4	89312
Load_5	10.000	Span_AD5	123510





Using numeric keys  ~  , set the counterweight values.

 = Set,  = Cancel

Set the span after affirming stability of AD values.





- Note 1. Set the weight of the counterweight to be within the range of 10%~100% of the maximum weight While initially being given as 100% of the maximum weight, enter again the desired weight value if the weight of the counterweight is different from this.
(Accuracy upon Calibration drops below 10%)
- Note 2. Repeat to execute inputting the counterweight value and setting the span as many times as multi setting steps.
In this case, set a larger value than the previous one for the weight value.

CAL 3(Gravity Calibration)

Setting Method	Display Part				
<p>1. Using numeric keys  ~ </p> <p>Enter an initial gravity value.</p> <p> = Set,  = Cancel</p> <p>2. Enter a local gravity value.</p>	<table border="0"> <tr> <td>Produ_Gr</td> <td>9.7994</td> </tr> <tr> <td>Local_Gr</td> <td>9.7994</td> </tr> </table>	Produ_Gr	9.7994	Local_Gr	9.7994
Produ_Gr	9.7994				
Local_Gr	9.7994				

Note 1: Use when gravity values are different between the production area and the sales area

CAL 4(Dual Range Setting)

Setting Method	Display Part				
<p>1. Set the use status for dual function 0= Not use, 1 = Use</p> <p>2. Using numeric keys  ~ </p> <p>Enter dual values.</p> <p> = Set,  = Cancel</p>	<table border="0"> <tr> <td>Produ_Gr</td> <td>9.7994</td> </tr> <tr> <td>Local_Gr</td> <td>9.7994</td> </tr> </table>	Produ_Gr	9.7994	Local_Gr	9.7994
Produ_Gr	9.7994				
Local_Gr	9.7994				

Note 1: Upon dual setting, the graduation is changed to minimum division * 2 beyond the dual section.

CAL 5(Zero & Span Adjustment)

Zero Adjustment

Setting Method	Display Part
<p>MENU = Set, CLEAR =Cancel Enter Clear</p> <p>Set the Zero after affirming stability of AD value (Zero is changed with reference to the currentAD)</p>	<p>CurrZero -43</p> <p>Curr_AD 6649</p>

Span Adjustment

Setting Method	Display Part
<p>Using numeric keys 0 ~ 9, Enter the desired factor value for change.</p> <p>MENU = Set, CLEAR =Cancel Enter Clear</p>	<p>Curr_Fac 333320</p> <p>Adjs_Fac XXXXXX</p>





CAL 6(Direct(Equivalent input) Weight Setting)

Setting Method	Display Part
<p>Using numeric keys 0 ~ 9, Enter the output value.</p> <p>MENU = Set, CLEAR =Cancel Enter Clear</p>	<p>InputZero(mV/V) 0.25462</p> <p>InputSpan(mV/V) 2.00000</p>

Note 1. Find zero, span output of the load cell for equivalent input.

Note 2. Set maximum weight and minimum division for CAL-1 before equivalent input.

CAL 8(Unit Select)

Setting Method	Display Part
<p>Using up, down keys  , </p> <p>Choose the unit</p> <p> = Set,  =Cancel</p>	<p><input type="checkbox"/> kg - Kilogram</p> <p><input type="checkbox"/> lb - Pound</p> <p><input type="checkbox"/> ton - ton</p> <p><input type="checkbox"/> g - gram</p>

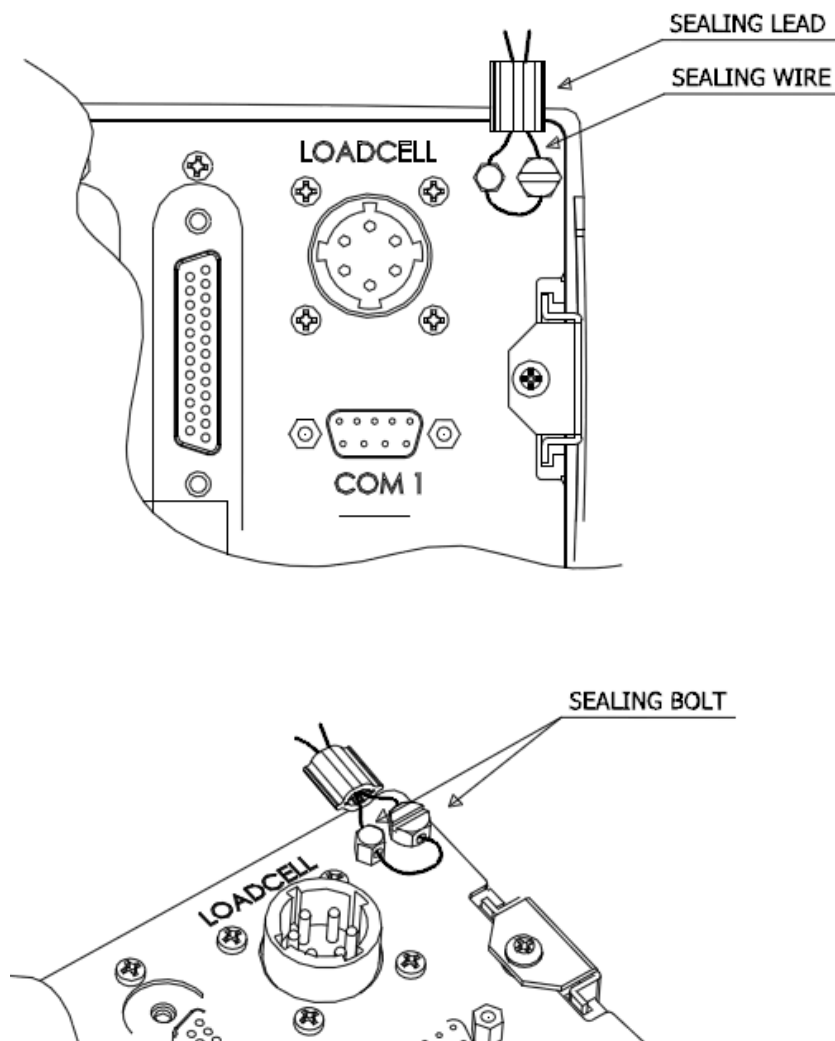

Note 1. Default unit is kg

4-2. How to Seal the Indicator (Sealing)

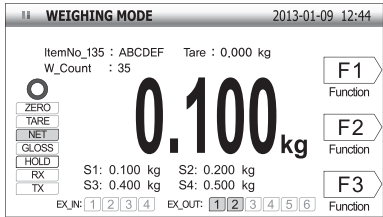

5. Weighing Mode

5-1. Zero function

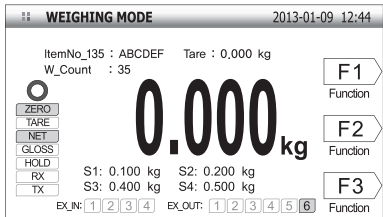

	Display Part or Used Keys	Load Plate	Description
Step 1		Empty	State with zero changed
Step 2			Push the zero key
Step 3		Empty	State after performing zero function. Namely, the current weight is designated as '0'kg.

Note 1. Operating range for the zero key is possible between $\pm 1\%$ ~ $\pm 99\%$ of the maximum weight.

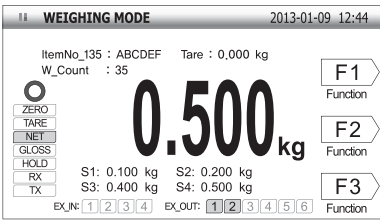

Operating range for the zero key is designated in Menu No. [2-1-16].

Note 2. Menu No. [2-1-14] designates whether to perform zero function only if the current weight is stabilized or even when it is unstable.

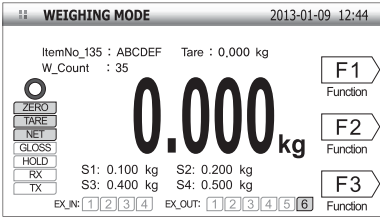
5-2. Tare function

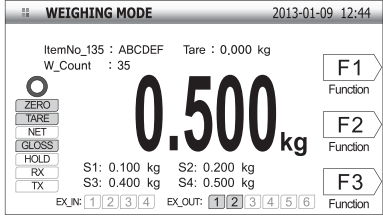

	Display Part or Used Keys	Load Plate	Description
Step 1		Tare Placement	State with tare placed on load plate
Step 2			Push the tare key
Step 3		Tare	State with tare lamp turned ON and tare registered

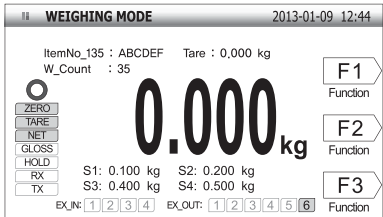
5-3. Net Weight/ Gross Weight Selection

	Display Part or Used Keys	Load Plate	Description
Step 1	 <p>The display shows 'WEIGHING MODE' at the top right with the date '2013-01-09 12:44'. Below this, it displays 'ItemNo_135 : ABCDEF' and 'Tare : 0.000 kg'. The main display shows 'W_Count : 35' and a large '0.500 kg'. To the right of the display are three function keys: 'F1 Function', 'F2 Function', and 'F3 Function'. At the bottom, there is a keypad with 'EX.IN:' and 'EX.OUT:' labels and numbered buttons (1-6).</p>	Tare	Tare Weight : 0.500 kg Gross Weight state is indicated
Step 2	 <p>A yellow key with 'G/N' and a downward-pointing arrow.</p>		Push the Gross Weight/net weight switching key
Step 3	 <p>The display shows 'WEIGHING MODE' at the top right with the date '2013-01-09 12:44'. Below this, it displays 'ItemNo_135 : ABCDEF' and 'Tare : 0.000 kg'. The main display shows 'W_Count : 35' and a large '0.000 kg'. To the right of the display are three function keys: 'F1 Function', 'F2 Function', and 'F3 Function'. At the bottom, there is a keypad with 'EX.IN:' and 'EX.OUT:' labels and numbered buttons (1-6).</p>	Tare	Current net weight value is indicated with net weigh lamp turned ON

Note 1. Push [Tare] key with the load plate empty to cancel the tare.

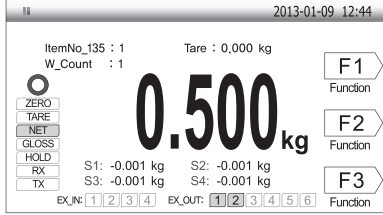
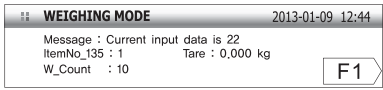

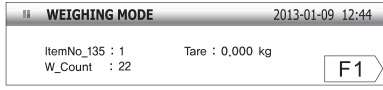
5-4. Item Number Change

	Display Part or Used Keys	Load Plate	Description
Step 1		0.500kg	Current item number is No. 10.
Step 2			Enter No.22
Step 3			Push the item number key
Step 4			Item number is changed to No. 22

Note 1. Item number may be designated as 0~99.

5-5. Subtotal Print

■ Assume that the item number of the reinforcing bar is '10'.

	Display Part or Used Keys	Load Plate	Description
Step 1			Select the item number code as '10'
Step 2			Push No.4(Subtotal) key "No.4 key pushed" is displayed in the message window
Step 3			The subtotal value of Item No.10 is printed in the designated form

Note 1. If F1 is set for the manual print. You can use this function



Note 2. Output form is designated as follows.

SUB-TOTAL	

DATE	2012/ 1/ 1
TIME	09:30
ID	1
COUNT	5
TOTAL	350.0 kg

Note 1. Subtotal DATA are deleted automatically or manually according to the Menu No.[2-3-09].

5-6. Total Print

	Display Part or Used Keys	Load Plate	Description
Step 1			Push No.5(Total) key "No.5 key pushed" is displayed in the message window
Step 2			Sum of all subtotal information in Item Nos.0~99 is printed as in the designated form.

Note 1. IfF1 is set it for the manual print. You can use this function

Note 2. Output form is designated as follows.

GRAND-TOTAL	

DATE	2012/ 1/ 2
TIME	10:30
ID	10
COUNT	123
TOTAL	12350.0 kg

Note 1. Total DATA are deleted automatically or manually according to the Menu No.[2-3-09]



5-7. Selection and Change of Article Information

1) Push  key in the scale mode, and the following screen appears.



MENU MODE					
1	Item No	1	2	Tare	0.000
3	SP1_Data	0.100	4	SP2_Data	0.250
5	SP3_Data	0.400	6	SP4_Data	0.500
7	SP5_Data	0.700	8	SP6_Data	0.700
9	Item Name				

- ⇒ Select the item to change an input value for using numeric keys.
- ⇒ Push  key to change to the previous state(weight weighing state).

5-8. How to Change Item Number

- ⇒ Push No.1 key to select the item number and push  key
- ⇒ Input window for item number is displayed
- ⇒ Enter a desired item number → Enter [1][1] and push  key
- ⇒ Information on Item No.11 is displayed, followed by return to the previous state

5-9. Change in Tare Weight

- ⇒ Push No.2 key to select the tare weight and push  key
- ⇒ Input window for the tare weight is displayed
- ⇒ Enter the desired tare value → Enter [1][0][0][0][0] and push  key (Tare value = 1000)

Change of set values 1~6

- ⇒ Push the relevant numeric key to select the item

MENU MODE					
1	Item No	1	2	Tare	0.000
3	SP1_Data	0.100	4	SP2_Data	0.250
5	SP3_Data	0.400	6	SP4_Data	0.500
7	SP5_Data	0.700	8	SP6_Data	0.700
9	Item Name				



- ⇒ Input window for the set value is displayed

MENU MODE	
M-3006 : SP4_Data	
Set Value:	0.100
Init Value:	0
Input Range:	0 - 999999

- ⇒ Input the desired value and push  key

6. Test Mode

How to Access to the Test Mode

Push the  in the weighing mode, by the  key to select test mode or when the power is turned on while pressing  key in the front of the indicator.

Push the  key in the test mode to return to weighing mode.

Test menu(1-9)

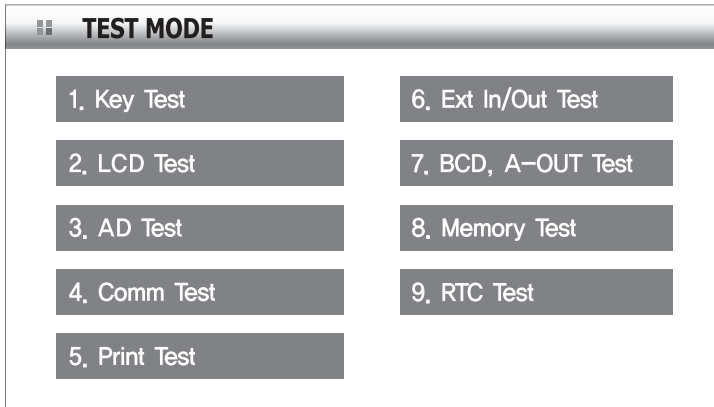



















1. Key Test
2. LCD Test
3. AD Test
4. Communication Test(COM1, COM2)
5. Print Test (COM2)
6. External Input/output Test
7. Option test
8. Memory test
9. RTC test

1. Key Test

Function : Key test		
Used Key	Used Key	Used Key
 : Upper Menu Other Key : Test	Key Code 7	When you press any key to test, the number and code for the key are displayed on the screen.



<Key List>

Key	No	Code	Key	No	Code	Key	No	Code
	1	1		8	8		163	163
	2	2		9	9		161	161
	3	3		0	0		48	48
	4	4		128	128		27	27
	5	5		162	162		30	30
	6	6		55	55			
	7	7		160	160			

2.LCD Test

Function : Display Screen Test	
Used Keys	Description
 : Upper Menu	LCD test proceeds in the order of Red -> White -> Green -> Yellow



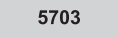





3.AD Test

Function : Load Cell Test		
Used Key	Display Part	Description
 : Upper Menu Enter	 	Output value of the Calibrated load cell is displayed.

Note 1. Check whether load cell output values are changed while loading and unloading a weight on the load plate.
 If the number is fixed or the number "0" is displayed, check again to note whether the load cell is correctly connected

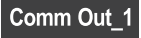
Note 2. When  key is pushed, the load cell output is displayed in the unit of mV/V

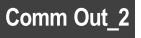
4.Communication Test

Function : Series Communication Test	
Used Keys	Display Part
 : Upper Menu Other Key : Test	       
Description	The value entered as Port No.1 is displayed in Communication Input 1 The value entered as Port No.2 is displayed in Communication Input 2 Simultaneously transmitted to Communication Outputs 1,2 upon key inputting

Note 1. Execute this test in the state of executing the communication program(Hyper Terminal) in the computer after connecting the series port of the computer and com port on the back face of the indicator.

Note 2. Click '1' to affirm whether the computer receives properly.

Note 3. Perform this test after designating the communication speed in advance in Menu No.[2-2-04 or 2-2-09].

5. Print Test

Function : Printer Test		
Used Keys	Display Part	Description
 : Upper Menu	Print	Print out the following form CAS Corporation Come And Succeed TEL 1577-5578 TEST OK

Note 1. Designate in advance the printer to be used in Menu No. [2-3-01].

6. External Input/ Output Test

Function : External Input/ Output Test		
Used Keys	Display Part	Description
 : Upper Menu Other Key : Test	<div style="display: flex; flex-direction: column; align-items: center;"> <div style="display: flex; align-items: center; margin-bottom: 10px;"> <div style="background-color: black; color: white; padding: 5px 10px; margin-right: 10px;">Ext In</div> <div style="background-color: #cccccc; padding: 5px 10px; margin-right: 10px;">1</div> </div> <div style="display: flex; align-items: center;"> <div style="background-color: black; color: white; padding: 5px 10px; margin-right: 10px;">Ext Out</div> <div style="background-color: #cccccc; padding: 5px 10px; margin-right: 10px;">3</div> </div> </div>	Displayed in the external input section when there is an external input. Push No.1~6 key to execute weighing external output

Note 1. This test operates only if Weighing Module Option Card is mounted

7.A-OUT, BCD OUT Test

Function : Option(Analog Out, BCD Out)Test		
Used Keys	Display Part	Description
 : Upper Menu Other Key : Test	<div style="display: flex; flex-direction: column; align-items: center;"> <div style="display: flex; align-items: center; margin-bottom: 10px;"> <div style="background-color: black; color: white; padding: 5px 10px; margin-right: 10px;">AOUT(%)</div> <div style="background-color: #cccccc; padding: 5px 10px; margin-right: 10px;">25P</div> </div> <div style="display: flex; align-items: center;"> <div style="background-color: black; color: white; padding: 5px 10px; margin-right: 10px;">BCD OUT</div> <div style="background-color: #cccccc; padding: 5px 10px; margin-right: 10px;">111111</div> </div> </div>	The output level of Aout is raised by 25% each time the key is pushed.

Note 1. This test operates only if Analog out or BCD out Option Card is mounted.

8.Memory Test



Function :Memory test		
Used Keys	Display Part	Description
 :Upper Menu	EEPROM Memory Error Flash Memory Error	If have some errors, display to bad point
	Memory Test O.K	If don't has any error, display to OK

9.RTC Test

Function :RTC test		
Used Keys	Display Part	Description
 :Upper Menu	<div style="display: flex; align-items: center; gap: 10px;"> <div style="background-color: #333; color: white; padding: 5px 10px; border-radius: 3px;">Time</div> <div style="background-color: #ccc; padding: 5px 10px; border-radius: 3px;">18:55:23</div> </div>	Display current time

7. Set Mode

7-1. How to Enter the Set Mode

Push the  in the weighing mode, by the  key to select set mode or when the power is turned on while pressing  key in the front of the indicator.

Push the  key in the set mode to return to weighing mode.

M-2100 : General Function

	M-2101 : Unit Select
	M-2102 : AD Speed
	M-2103 : Digital Filter Buffer
	M-2104 : Digital Filter Level
	M-2105 : Digital Filter T_Constant
	M-2106 : Stable Range
	M-2107 : Auto Zero Range
	M-2108 : Weight Back up
	M-2109 : Hold Type
	M-2110 : Average Hold Time
	M-2111 : Hold Clear Condition
	M-2112 : Auto Hold Condition
	M-2113 : Auto Hold Clear Condition
	M-2114 : Key Operating Condition
	M-2115 : Zero Key Range
	M-2116 : Tare Key Range
	M-2117 : Initial Zero Range
	M-2118 : Overload Range
	M-2119 : Lock Front keys
	M-2120 : Set F1 key Function
	M-2121 : Set F2 key Function
	M-2122 : Set F3 key Function
	M-2123 : Near Zero(Print, Relay)

**M-2200 :
Communication Function**

	M-2201 : Device ID
	M-2202 : Data Transmission Rate
	M-2203 : COM1 Port Setting
	M-2204 : COM1 Baudrate
	M-2205 : COM1 Out Data
	M-2206 : COM1 Output Format
	M-2207 : COM1 Output Mode
	M-2208 : COM2 Port Setting
	M-2209 : COM2 Baudrate
	M-2210 : COM2 Out Data
	M-2211 : COM2 Output Format
	M-2212 : COM2 Output Mode

M-2300 : Print Function

	M-2301 : Print Type
	M-2302 : Print Form
	M-2303 : Manage Print Data
	M-2304 : Print Line Feed
	M-2305 : Print Head Messgae
	M-2306 : Print Delay Time
	M-2307 : Print Condition
	M-2308 : Print Set Automatic
	M-2309 : Print Count Number

M-2400 : Option Function

	M-2404 : Adjust Zero(Aout)
	M-2405 : Adjust Span(Aout)
	M-2406 : Max Weight(Aout)
	M-2407 : BCD Out Type

M-2500 : Device Function

	M-2501 : Set value Initialize
	M-2502 : Connect to PC
	M-2503 : Set Date
	M-2504 : Set Time
	M-2505 : Set Password
	M-2506 : USB Backup
	M-2507 : LCD Bright

7-2. General Functions

Menu-2101

Function	Set Unit	
Set Range (1~3)	Display Part	Meaning
	<input type="checkbox"/> 1_kg	kilogram (kg)
	<input type="checkbox"/> 2_Lb	pound (lb)
	<input type="checkbox"/> 3_ton	ton

Menu-2102

Function	Set AD Speed	
Set Range (0~4)	Display Part	Meaning
	Set Value 0	AD Switching Speed 10 times per second
	Set Value 1	AD Switching Speed 15 times per second
	Set Value 2	AD Switching Speed 40 times per second
	Set Value 3	AD Switching Speed 100 times per second
	Set Value 4	AD Switching Speed 200 times per second

Menu-2103

Function	Set Digital Filter_1	Buffer
Set Range (1~50)	Display Part	Meaning
	Set Value : XX	Setting the number of buffers in the digital filter
	Initial Value : 10	

Note 1. Set it so as to be suite to the environment (Speed for weight changes may slow down)

Menu-2104

Function	Set Digital Filter_1	Level
Set Range (1~50)	Display Part	Meaning
	Set Value : XX	Setting the level of the digital filter (The more stable the weight, the higher the level)
	Initial Value : 10	

Menu-2105

Function	Set Digital Filter_2	Time Constant
Set Range (1~200)	Display Part	Meaning
	Set Value : XX	Setting the time constant of the digital filter (The more stable the weight, the higher the constant)
	Initial Value : 50	

Note 1. Set it so as to be suite to the environment (Speed for weight changes may slow down)

Menu-2106

Function	Set Stable Range	
Set Range (0 ~99)	Display Part	Meaning
	<input type="radio"/> x 0.5 division Initial Value: 1x 0.5 division	Stability lamp is turned ON when weight change is such that the width of change in a given time is within the set value x 0.5 division

Note 1. Function that acknowledges it as the stable state when the width of weight change within a set time does not exceed the set range X 0.5 division.

Note 2. Weighing stabilization will be made faster by setting the larger number if the environment involves much vibration in the surrounding and by setting the smaller number if there is little vibration.

Menu-2107

Function	Set Automatic Zero Tracking Compensation	
Set Range (0 ~99)	Display Part	Meaning
	<input type="radio"/> x 0.5 division Initial Value: 1x 0.5 division	Function to compensate for zero when weight change is such that the width of change in a given time is within the set value x 0.5 division

Note 1. This function automatically calibrates for zero if the weight does not exceed a given range of division within a given time in the zero state.

Ex) When the maximum display division is 120.0Kg with the value of one division set as 0.05Kg, provided that the Menu[2-1-07] is set as "2",

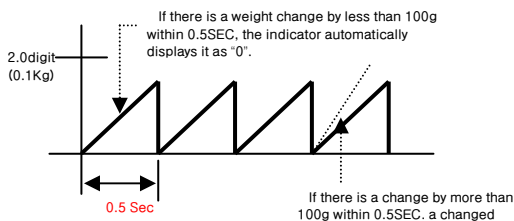

Menu-2108

Function	Set Weight Back up	
	Display Part	Meaning
Set Range (1, 2)	<input type="checkbox"/> 1_ Weight back up not used	Weight back up function is not used
	<input type="checkbox"/> 2_ Weight back up used	Weight back up is used (based on operation)

Note 1. Select the function using numeric keys or arrow keys and push the [Enter] key for storage

Note 2. As the Back-up state remembers the initial zero state of the weighing instrument upon power failure or power supply turned OFF, the weight value is displayed when the power supply is ON if weighing object is placed in the weighing instrument.
If the weighing tare is empty, push the "zero" key to have the zero remembered again.

Menu-2109

Function	Set Hold Type	
	Display Part	Meaning
Set Range (1 ~4)	<input type="checkbox"/> 1_ Average Value Hold	Average Hold :Average the wavering weight over a set time and hold upon using the Hold key or external inputting
	<input type="checkbox"/> 2_ Peak Hold	PEAK Hold : Hold the maximum value of the wavering weight
	<input type="checkbox"/> 3_ Sampling Value Hold	SAMPLING Hold : Hold sampled value of the wavering weight upon using the Hold Key or external inputting
	<input type="checkbox"/> 4_ Automatic Hold	Auto Peak Hold :Automatically calculate the maximum value of the wavering weight

Note 1. Select the function using numeric keys or arrow keys and push [Enter] key for storage

Note 2. Hold function is not performed if the applied weight value exceeds the maximum weight value during Hold operation.

Note 3. Upon setting No.'2, if a load is applied while the load plate is empty, the maximum value of the applied load is automatically calculated and displayed.

Menu-2110

Function	Set Average hold time	
	Display Part	Meaning
Set Range (00 ~ 99)	00 X 0.1 Sec Initial Value: 30x 0.1 Sec	Average value within the set value x 0.1 sec is calculated

Menu-2111

Function	Set Hold Canceling Conditions	
Set Range (1~3)	Display Part	Meaning
	<input type="checkbox"/> 1_Cancel Hold at zero	Hold is canceled when it becomes zero.
	<input type="checkbox"/> 2_Cancel upon entering Hold Key	Hold is canceled when Hold key is entered.
	<input type="checkbox"/> 3_Cancel upon entering Hold less Key	Hold is canceled when Hold less key is entered.

Menu-2112

Function	Set Automatic Hold Starting Conditions	
Set Range (0, 99)	Display Part	Meaning
	<input type="checkbox"/> x 1 division Initial Value: 10x 1 division	Hold starts when the weight changes within the set range value x 1 division.

Menu-2113

Function	Set Automatic Hold Canceling Conditions	
Set Range (0~99)	Display Part	Meaning
	<input type="checkbox"/> % Initial Value: 10 %	Hold is canceled when the value is changed by more than <input type="checkbox"/> % of the held value.

Menu-2114

Function	Set Ker Operating Conditions (ZERO, TARE Keys Availability)	
Set Range (1, 2)	Display Part	Meaning
	<input type="checkbox"/> 1_Always Operational	Always in operation
	<input type="checkbox"/> 2_Operational when the weight is stable	Operates only if the weight is stable

Menu-2115

Function	Set Zero Key Range	
Set Range (0~99)	Display Part	Meaning
	<input type="checkbox"/> % Initial Value: 10 %	Zero key operates up to within +/- <input type="checkbox"/> % of the maximum weight

Menu-2116

Function	Set Tare Key Range	
	Display Part	Meaning
Set Range (0~100)	00 % Initial Value: 100 %	Tare key operates up to within +/-00% of the maximum weight

Menu-2117

Function	Set Initial Zero Range	
	Display Part	Meaning
Set Range (0~99)	00 % Initial Value: 10%	Initial zero operates within +/-00% of the Gross Weight

Menu-2118

Function	Set Overload Range	
	Display Part	Meaning
Set Range (0~99)	0 x 1 Digit Initial Value: 9x 1 Digit	Overweight from the next to 0 x 1 Digit of the maximum weight

Menu-2119

You can select the function key for use or not
Green = Enable, Red = Disable

Ex) If you want disable the F1 key, press the F1 key and set to red color of F1 key on the display

Menu-2120: F1 Key Use Type**Menu-2121: F2 Key Use Type****Menu-2122: F3 Key Use Type**

Function	Set Key Use Type	
Set Range (1~19)	Display Part	Meaning
	□ 1_Zero Key	F key used as the zero key
	□ 2_Total/Net Weight Key	F key used as the total/net weight key
	□ 3_Tare Key	F key used as the tare key
	□ 4_Subtotal Key	F key used as the subtotal key
	□ 5_Total Key	F key used as the total key
	□ 6_Clearing Key	F key used as the clearing key
	□ 7_Print Key	F key used as the print key
	□ 8_HoldKey	F key used as the hold key
	□ 9_Tare Cancelling Key	F key used as the tare cancelling key
	□ 10_Step1 Set Value Entering Key	F key used as the step 1 setting key
	□ 11_Step2 Set Value Entering Key	F key used as the step 2 setting key
	□ 12_Step3 or 1 Fall Key	F key used as the step 3 setting key
	□ 13_Step4 or 2 Fall Key	F key as the step 4 setting key
	□ 14_Upper Limit Input	F key used as the upper limit input key
	□ 15_Lower Limit Input	F key used as the lower limit input key
	□ 16_Start Key	F key used as the start key
	□ 17_Stop Key	F key used as the stop key
	□ 18_Print Form Key	F key used as the print form key
□ 19_Holdless Key	F key used as the holdless key	

Note 1. The base setting of F1 key is the Print key.

Note 2. The base setting of F2 key is the Hold key

Note 3. The base setting of F3 key is the Tare Cancelling key.

Menu-2123

Function	Set Near Zero(Print, Relay)	
Set Range (0~99)	Display Part	Meaning
	□ x 1 Digit Initial Value: 0x 1 Digit	Up to the set value * 1 Digit is allowed as the zero

7-3. Communication Setting

Menu-2201

Function	Set Device ID	
Set Range (0 ~ 100)	Display Part	Meaning
	Device ID : 00 Initial Value: 0	Desired device ID may be entered.

Note 1. This function may be used as the indicator's inherent ID in the COMMAND mode.

Menu-2202

Function	Set Data Transmission Rate	
Set Range (1 ~ 9999)	Display Part	Meaning
	00 x 10ms Initial Value: 50 x 10ms	Data are transmitted by the unit of 00 x 10ms

Note 1. Data are transmitted in real time upon setting at "0".

Menu-2203

Function	Com1 Port Setting	
Set Range (1 ~ 6)	Display Part	Meaning
	□ 1_Data_8 / Stop_1 / Parity_none	Data Bit 8, Stop Bit 1, Parity Bit : None
	□ 2_Data_7 / Stop_1 / Parity_even	Data Bit 7, Stop Bit 1, Parity Bit: Even
	□ 3_Data_7 / Stop_1 / Parity_odd	Data Bit 7, Stop Bit 1, Parity Bit: Odd
	□ 4_Data_7 / Stop_2 / Parity_odd	Data Bit 7, Stop Bit 2, Parity Bit: Odd
	□ 5_Data_8 / Stop_1 / Parity_even	Data Bit 8, Stop Bit 1, Parity Bit: Even
□ 6_Data_8 / Stop_1 / Parity_odd	Data Bit 8, Stop Bit 1, Parity Bit: Odd	

Menu-2204

Function	Set COM1 Baud Rate	
	Display Part	Meaning
Set Range (1~8)	<input type="checkbox"/> 1_1,200 bps	1,200 bps
	<input type="checkbox"/> 2_2,400 bps	2,400 bps
	<input type="checkbox"/> 3_4,800 bps	4,800 bps
	<input type="checkbox"/> 4_9,600 bps	9,600 bps
	<input type="checkbox"/> 5_19,200 bps	19,200 bps
	<input type="checkbox"/> 6_38,400 bps	38,400 bps
	<input type="checkbox"/> 7_57,600 bps	57,600 bps
	<input type="checkbox"/> 8_115,200 bps	115,200 bps

Menu-2205

Function	Set Com1 Out Data	
	Display Part	Meaning
Set Range (1~3)	<input type="checkbox"/> 1_Displaed Value	Displayed value is transmitted
	<input type="checkbox"/> 2_Gross Weight	Gross Weight is transmitted
	<input type="checkbox"/> 3_Net Weight	Net weight is transmitted

Menu-2206

Function	Set COM1 Output Format	
	Display Part	Meaning
Set Range (1~4)	<input type="checkbox"/> 1_CAS 22	22 byte of CAS
	<input type="checkbox"/> 2_CAS10	10 byte of CAS
	<input type="checkbox"/> 3_AND18	18 byte Format(AND, FINE)
	<input type="checkbox"/> 4_CAS 22 Relay status	22 byte of CAS with relay status

Note 1. Note <Appendix 1> for communication format

Menu-2207

Function	Set Com1 Output mode	
	Display Part	Meaning
Set Range (1~9)	□ 1_No Data Output	Data is not transmitted
	□ 2_Transmit When Print Key is Pushed	Transmitted only if the print key is pushed
	□ 3_Transmit in Both Stable/Unstable Cases	Transmitted in both stable/unstable cases (Stream Mode)
	□ 4_Transmit Only if Weight Is Stable	Transmitted only if the weight is stable
	□ 5_Command Type 1	Command Type 1
	□ 6_Command Type 2	Command Type 2
	□ 7_Command Type 3	Command Type 3
	□ 8_Transmit upon Completion Signal	Transmitted only upon completion signal
	□ 9_Modbus	Modbus protocol

Note 1. See Appendices 2, 3, 4 for command types

Menu-2208

Function	Com2 Port Setting(RS232, Print)	
	Display Part	Meaning
Set Range (1~6)	□ 1_Data_8 / Stop_1 / Parity_none	Data Bit 8, Stop Bit 1, Parity Bit : None
	□ 2_Data_7 / Stop_1 / Parity_even	Data Bit 7, Stop Bit 1, Parity Bit : Even
	□ 3_Data_7 / Stop_1 / Parity_odd	Data Bit 7, Stop Bit 1, Parity Bit : Odd
	□ 4_Data_7 / Stop_2 / Parity_odd	Data Bit 7, Stop Bit 2, Parity Bit: Odd
	□ 5_Data_8 / Stop_1 / Parity_even	Data Bit 8, Stop Bit 1, Parity Bit: Even
	□ 6_Data_8 / Stop_1 / Parity_odd	Data Bit 8, Stop Bit 1, Parity Bit: Odd

Menu-2209

Function	Set COM2 Baud Rate	
	Display Part	Meaning
Set Range (1~8)	<input type="checkbox"/> 1_1,200 bps	1,200 bps
	<input type="checkbox"/> 2_2,400 bps	2,400 bps
	<input type="checkbox"/> 3_4,800 bps	4,800 bps
	<input type="checkbox"/> 4_9,600 bps	9,600 bps
	<input type="checkbox"/> 5_19,200 bps	19,200 bps
	<input type="checkbox"/> 6_38,400 bps	38,400 bps
	<input type="checkbox"/> 7_57,600 bps	57,600 bps
	<input type="checkbox"/> 8_115,200 bps	115,200 bps

Menu-2210

Function	Set Com2 Out Data	
	Display Part	Meaning
Set Range (1~3)	<input type="checkbox"/> 1_Displaed Value	Displayed value is transmitted
	<input type="checkbox"/> 2_Gross Weight	Gross Weight is transmitted
	<input type="checkbox"/> 3_Net Weight	Net weight is transmitted

Menu-2211

Function	Set COM2 Output Format	
	Display Part	Meaning
Set Range (1~4)	<input type="checkbox"/> 1_CAS 22	22 byte of CAS
	<input type="checkbox"/> 2_CAS10	10 byte of CAS
	<input type="checkbox"/> 3_AND18	18 byte Format(AND, FINE)
	<input type="checkbox"/> 4_CAS 22 Relay status	22 byte of CAS with relay status

Note 1. See <Appendix 1> for communication format

Menu-2212

Function	Set Com2 Output mode	
	Display Part	Meaning
Set Range (1~9)	□ 1_No Data Output	Data is not transmitted
	□ 2_Transmit When Print Key is Pushed	Transmitted only if the print key is pushed
	□ 3_Transmit in Both Stable/Unstable Cases	Transmitted in both stable/unstable cases (Stream Mode)
	□ 4_Transmit Only if Weight Is Stable	Transmitted only if the weight is stable
	□ 5_Command Type 1	Command Type 1
	□ 6_Command Type 2	Command Type 2
	□ 7_Command Type 3	Command Type 3
	□ 8_Transmit upon Completion Signal	Transmitted only upon completion signal
	□ 9_Modbus	Modbus protocol

Note 1. See Appendices 2, 3, 4 for command types

7-4. Print Function Setting

Menu-2301

Function	Set Printer Type	
	Display Part	Meaning
Set Range (1~6)	<input type="checkbox"/> 1_Printer Not Used	Printer is not used
	<input type="checkbox"/> 2_DEP_CAS Ticket Printer	CAS Ticket Print Standard Type
	<input type="checkbox"/> 3_DLP Label Printer	CAS Label Print Standard Type
	<input type="checkbox"/> 4_BP Label Printer	CAS BP Label Printer
	<input type="checkbox"/> 5_CP7100/7200 (ENG)	CP7100/7200 English
	<input type="checkbox"/> 6_CP7100/7200 (KOR)	CP7100/7200 Korean

Menu-2302

Function	Set Print Form	
	Display Part	Meaning
Set Range (1~8)	<input type="checkbox"/> 1_Print Form_1/BP Form1	Print Form 1 (Date, Time, Serial No., Item No., Net Weight) BP Print Form 1(FORM1)
	<input type="checkbox"/> 2_Print Form_2/BP Form2	Print Form 2 (Date, Time, Weighing No., Net Weight) BP Print Form 2(FORM2)
	<input type="checkbox"/> 3_Print Form_3/BP Form3	Print Form 3 (Date, Time, Gross Weight, Tare, Net Weight) BP Print Form 3(FORM3)
	<input type="checkbox"/> 4_Print Form_4/BP Form4	Print Form 4 (Date, Time, Net Weight) BP Print Form 4(FORM4)
	<input type="checkbox"/> 5_Print Form_5/BP Form5	Print Form 5 (Date, Time, Item No., Net Weight) BP Print Form 5(FORM5)
	<input type="checkbox"/> 6_Print Form_6/BP Form6	Print Form 6 (Date, Time, Serial No., Net Weight) BP Print Form 6(FORM6)
	<input type="checkbox"/> 7_Print Form_7/BP Form7	Print Form 7 (Date, Time, Item Name, Item No., Net Weight) BP Print Form 7(FORM7)
	<input type="checkbox"/> 8_Print Form_8/BP Form8	Print Form 6 (Date, Time, Item Name, Net Weight) BP Print Form 8(FORM8)

【 Form 1 】
 Date, Time,
 Serial No., Item No., Net
 Weight

2009.07.07[TUE]	12:30:46
1, ID_11,	50.0 kg
2, ID_12,	100.0 kg
3, ID_19,	200.5 kg

【 Form 2 】
 Date, Time,
 Weighing No., Net Weight

2009.07.07[TUE]	12:30:46
No. 1	50.0 kg
No. 2	100.0 kg
No. 3	200.5 kg

【 Form 3 】
 Date, Time,
 Gross Weight, Tare, Net
 Weight

2009.07.07[TUE]	12:30:46
Gross :	1000.0 kg
Tare :	0.0 kg
Net :	1000.0 kg
Gross :	2000.0 kg
Tare :	500.0 kg
Net :	1500.0 kg

【 Form 4 】
 Date, Time,
 Net Weight

2009.07.07[TUE]	12:30:46
10:10:30	Net: 50.0 kg
11:00:32	Net: 100.0 kg
12:30:34	Net: 200.5 kg

【 Form 5 】
 Date, Time,
 Item No., Net Weight

2009.07.07[TUE]	12:30:46
ID_11, Net:	50.0 kg
ID_12, Net:	100.0 kg
ID_19, Net:	200.5 kg

【 Form 6 】
 Date, Time,
 Serial No., Net Weight

2009.07.07[TUE]	12:30:46
1,	1000.0 kg
2009.07.07[TUE]	12:32:56
2,	200.5 kg

【 Form 7 】
 Date, Time,
 Item Name
 Item No., Net Weight

2009.07.07[TUE]	12:30:46
Cement	
ID_11, Net:	50.0 kg
Cement	
ID_11, Net:	50.0 kg

【 Form 8 】
 Date, Time,
 Item Name., Net Weight

2009.07.07[TUE]	12:30:46
Cement	50.0 kg
2009.07.07[TUE]	12:30:46
Cement	150.0 kg

□ CAS DLP Protocol

Parameter	Description	Data Length
V00	Gross Weight	7 byte
V01	Tare Value	7 byte
V02	Net Weight	7 byte
V03	Barcode (net weight)	6 byte
V04	Item Number	2 byte
V05	Item Name	10 byte
V06	Print count	2 byte
V07	Date	10 byte
V08	Time	8 byte

□ CAS BP Series Printer Protocol

.Parameter	Description	Data Length
V00	Gross Weight	7 byte
V01	Tare Value	7 byte
V02	Net Weight	7 byte
V03	Net ('.' omit) : for bar code	6 byte
V04	Item Number	2 byte
V05	Item Name	10 byte
V06	Print count	3 byte
V07	Date	10 byte
V08	Time	8 byte
V09	Unit(kg)	2 byte
V10	Total Net ('.' include)	9 byte

Menu-2303

Function	Manage Print Data	
Set Range (1 ~ 2)	Display Part	Meaning
	□ 1_Acc Value Cleared upon Printing	Accumulated value is cleared upon printing
	□ 2_Acc Value Not Cleared upon Printing	Cleared when the clearing key is pushed

Menu-2304

Function	Set Print Line feed	
Set Range (0~99)	Display Part	Meaning
	○○ Line Initial Value: 1 Line	Set a spacing between lines as the set value upon printing

Menu-2305

Function	Set Print Head Message	
	Display Part	Meaning
Set Range 50 byte	message	Enter Message

Note 1. A function entering the desired head message upon printing.

Menu-2306

Function	Set Printing Delay Time	
	Display Part	Meaning
Set Range (0 ~ 200)	00 x 10ms	Issue print after 00 x 10ms
	Initial Value: 1 x 10ms	

Menu-2307

Function	Set Print Condition	
	Display Part	Meaning
Set Range (1~3)	<input type="checkbox"/> 1_ Print Only If Weight Value Is +	Print out only if the weight value is +
	<input type="checkbox"/> 2_ Print Only If Weight Value Is -	Print out only if the weight value is -
	<input type="checkbox"/> 3_ Print Regardless of Whether Weight Value Is +/-	Print out regardless of whether the weight value is +/-

Menu-2308

Function	Set Print Out Condition (Printing condition)	
	Display Part	Meaning
Set Range (1~3)	<input type="checkbox"/> 1_ Manual Print	Printed only if the print key is pushed
	<input type="checkbox"/> 2_ Automatic Print	Printed automatically if the weight value is stabilized
	<input type="checkbox"/> 3_ Finish Print	Printed automatically if the finish signal out in relay operation

Note 1. Finish print function is not use in the CI-601 model

Menu-2309: Printing Count Number

Function	Print Count Number	
	Display Part	Meaning
Set Range (1 ~ 2)	<input type="checkbox"/> 1_ No Change	Fixed
	<input type="checkbox"/> 2_ Increased 1	Printing times are increased automatically by one at a time after weighing operation

7-5. Option Setting

Menu-2404

Function	Adjust the Zero Output upon Using Analog Out option	
	Display Part	Meaning
Set Range (0 ~ 24000)	0000	0.000 mA, 0 V output
	4000	4.000 mA, 2 V output
	4015	4.015 mA, 2.007 V output

Menu-2405

Function	Adjust the Maximum Output upon Using Analog Out option	
	Display Part	Meaning
Set Range (0 ~ 24100)	10000	10.000 mA, 4.16 V output
	20000	20.000 mA, 8.33 V output
	24000	24.000 mA, 10 V output

Menu-2406

Function	Maximum Output Weight Value upon Using Analog Out option	
	Display Part	Meaning
Set Range (0 ~ 99999)	1000	Maximum output at 1000 kg
	2000	Maximum output at 2000 kg

Menu-2407

Function	BCD Out Type	
	Display Part	Meaning
Set Range (1~2)	<input type="checkbox"/> 1_Positive	Bcd out set to positive logic
	<input type="checkbox"/> 2_Negative	Bcd out set to negative logic

7-6. Hardware Set Function

Menu-2501

Function	Set Value Initialization	
Set Range (1~2)	Display Part	Meaning
	□ 1_ Set Value Not Initialized	No set values of the product are initialized to factory shipping state
	□ 2_ Set Value Initialization Executed	All set values of the product are initialized to factory shipping state

Menu-2502

Function	PC Connection	
PC and Data Communication	Display Part	Meaning
	PC Connection	Used when Item data or Setting data backup function is performed through PC

Menu-2503

Function	Set Date	
Numeric Key : Data Designation	Display Part	Meaning
	10.08.17	August 17th, 2010

Menu-2504

Function	Set Time	
Numeric Key : Data Designation	Display Part	Meaning
	11.30.10	30 minutes and 10seconds past 11 o'clock in the morning

Menu-2505

Function	Set Password	
Set Range (1 ~ 2)	Display Part	Meaning
	□ 1_ Password Not Used upon Moving the Mode	Password entry is not used upon entering the setting mode
	□ 2_ Password Used upon Moving the Mode	Password entry is used upon entering the setting mode

Function	Set Password	
Set Range (0 ~ 9999)	Display Part	Meaning
	XXXX	4-digit number entered is used as the password

Menu-2506

Function	USB Back up Function	
Set Range (1 ~ 2)	Display Part	Meaning
	□ 1_ Data Not Stored	Only the quantity of the stored Data is affirmed
	□ 2_ Data Stored	Data are stored in the USB memory

Note1. Print data is save to USB memory.

Note2. Data are stored in the following format upon Data Backup.

Item_01	count_01
13.01.01	12:00:00
Weight:	10,000kg
Tare :	5,000kg
Gross :	15,000kg

Menu-2507

Function	Set LCD Bright	
Set Range (1 ~ 7)	Display Part	Meaning
	Set Value _ 1	LCD brightness 10%
	Set Value _ 2	LCD brightness 30%
	Set Value _ 3	LCD brightness 50%
	Set Value _ 4	LCD brightness 70%
	Set Value _ 5	LCD brightness 80%
	Set Value _ 6	LCD brightness 90%
	Set Value _ 7	LCD brightness 100%

8. RS-232C Interface in Detail

8-1. RS-232C Port Connection

(1) COM - TXD: Pin No. 2, RXD: Pin No. 3, GND: Pin No. 7

TXD	2 O
RXD	3 O
GND	7 O

9 pin port (male)
RS-232C port of CI-600

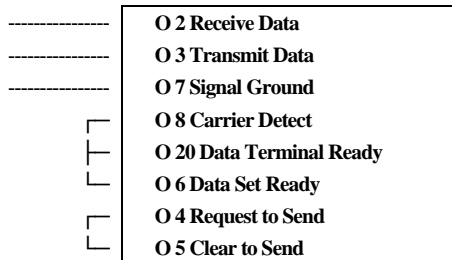

25 pin port (female)
Serial port of the computer

(2) COM2 - RXD: Pin No. 2, TXD: Pin No. 3, GND: Pin No. 7 (Option)

TXD	2 O
RXD	3 O
GND	7 O

9 pin port (male)
RS-232C port of CI-600

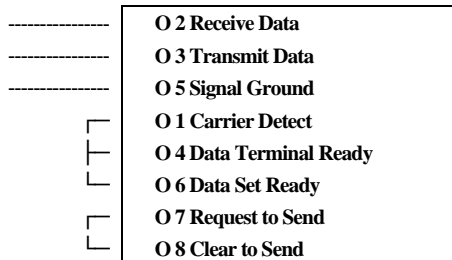

9 pin port (female)
Serial port of the computer

8-2. How to Connect an Auxiliary Display

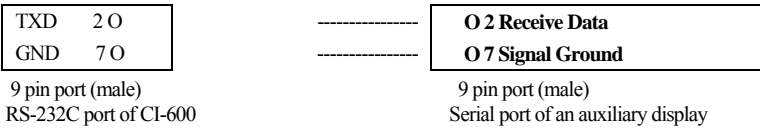

8-3. How to Connect a Label Printer (DLP)

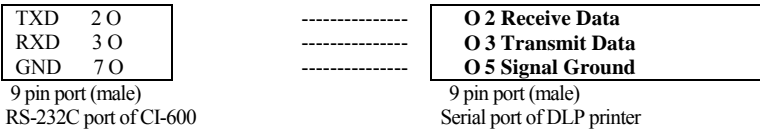

Note. Refer to page 38 (Set Mode) for RS-232C communication and setting method.

8-4. RS-422 & 485 Serial Communications

RS-422 & 485 transmit signals with the voltage difference, which are more stable for electric noises than other communication methods.

In addition, the AC Power Cable or other electric wires should be placed separately, and the shield cable (0.5Φ or more) dedicated to communications should be applied.

The recommended use distance is within 1.2km.

▶ Setting output method

The same as RC232C before

▶ Signal Format and Data Format

The same as RC232C before

- 422 Connection Diagram -

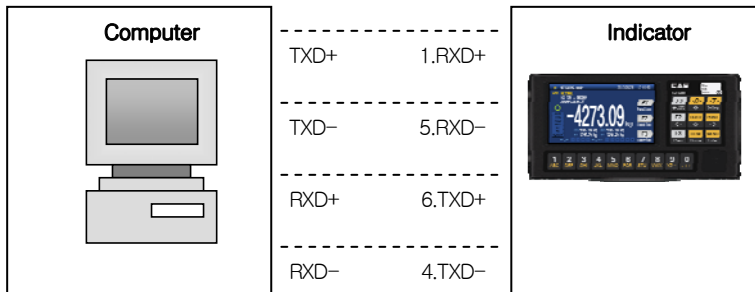

- 485 Connection Diagram -

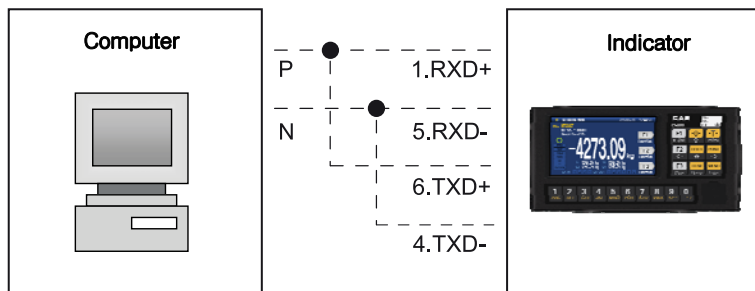

MAX 485 IC is MAX3491(3.3V)

9. Serial Data Information

9-1. CAS 22Bytes Format

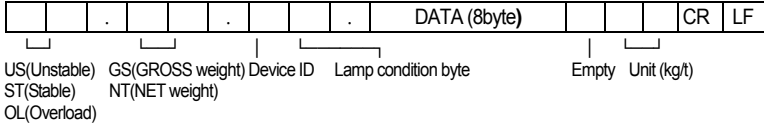

- Device ID: Send ing 1 byte of device ID to selectively receive the information from the indicator to the receiver.

(Device ID is set in F26.)

- Data (8 bytes): When the weight date including a decimal, for example, 13.5 kg, 8 bytes of ASCII code corresponding to '0', '0', '0', '0', '1', '3', '.' and '5' are sent.

- Lamp Status Byte

Bt7	Bt6	Bt5	Bt4	Bt3	Bt2	Bt1	Bt0
1	Stable	0	Hold	Printer	Gross Weight	Tare	Zero Point

9-2. CAS 10Bytes

(1) Code: ASCII (2) Transmission data format: (10 bytes)

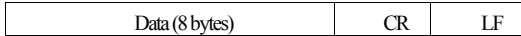

9-3. AND 18bytes

(1) Code: ASCII (2) Transmission data format (18 bytes)

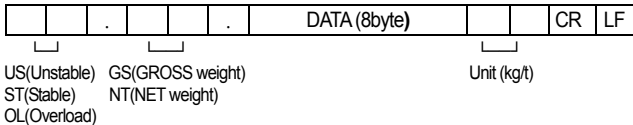

10. Appendix

Appendix 1> Command Mode 1 Description CAS <NT-500 Command>

Indicator Reception	Function	Indicator Response
dd RW CR LF	Request for Weight Data	Transmit the data in the set format upon command input
dd MZ CR LF	Same as Zero Key	Execute the zero and retransmit dd MZ CR LF to PC upon command input
dd MT CR LF	Same as Tare Key	Execute tare and retransmit dd MT CR LF to PC upon command input
dd PN 00 CR LF	Input Item No.(00~50)	Change the item no. and retransmit dd PN 00 CR LF to PC upon command input.
dd OP CR LF	Same as Start Key	Execute the start and retransmit dd OP CR LF to PC upon command input
dd EM CR LF	Same as Stop Key	Execute the stop and retransmit dd EM CR LF to PC upon command input

* dd : Device ID. (ASCII Code : 0x30 (hex), 0x31(hex if the Device ID is "01")

* 00000,00 : Set value for upper limit/lower limit/upper limit
fall/lower limit fall

(ASCII Code : 0x30(hex), 0x30(hex), 0x33(hex), 0x34(hex),
0x35(hex) if the set value is "00345")

* When it fails to execute the command : ! CR LF is transmitted to the computer.

* When there is an error in the command : ? CR LF is transmitted to the computer.

Appendix 2> Command Mode 2 Description

CAS <NT-570 Command>

Command data to NT-570A												Command description	NT-570A Respond
0	1	2	0	1	2	0	1	2	0	1	2		
D	ID	K	Z	CR	LF							ZERO key	
D	ID	K	T	CR	LF							TARE key	Return the received
D	ID	K	G	CR	LF							GROSS key	Return the received
D	ID	K	N	CR	LF							NET key	Return the received
D	ID	K	S	CR	LF							START key	Return the received
D	ID	K	P	CR	LF							STOP key	Return the received
D	ID	K	B	CR	LF							Print key	Return the received
D	ID	K	C	CR	LF							Total print key	Return the received
D	ID	K	W	CR	LF							Request weight data	Return the received
D	ID	H	T	CR	LF							Request set point value	Send Format 2
D	ID	S	1	0	0	0	0	0	0	CR	LF	1 st Step value	Return the received
D	ID	S	2	0	0	0	0	0	0	CR	LF	2nd Step value	Return the received
D	ID	S	3	0	0	0	0	0	0	CR	LF	3rd Step value	Return the received
D	ID	S	4	0	0	0	0	0	0	CR	LF	4th Step value	Return the received
D	ID	S	5	0	0	0	0	0	0	CR	LF	High limit value	Return the received
D	ID	S	6	0	0	0	0	0	0	CR	LF	Low limit value	Return the received
D	ID	H	E	0	0	0	0	0	0	CR	LF	Set point code(00-99)	Return the received

(D, ID:00-99, CR : 0×13, LF: 0×10, Command HC, HE range=00~99)

*** Format 1 : PC send set point all data to indicator NT-580A**

0	1	2	3	4	5	6	7	8	9	10	11	12	13	14	15	16	17	18	19		
D	ID	H	A	Set point code						,	Zero Band						,	Optional-			
20	21	22	23	24	25	26	27	28	29	30	31	32	33	34	35	36	37	38	39		
Preli		,	Preliminary						,	Final value						,	Free Fall				
40	41	42	43	44	45	46	47	48	49	50	51	52	53								
,	High limit						,	Low limit												CR	LF

*** Format 2 : Recieve the request data from PC then response of Indicator**

0	1	2	3	4	5	6	7	8	9	10	11	12	13	14	15	16	17	18	19		
D	ID	H	T	Set point code						,	Zero Band						,	Optional-			
20	21	22	23	24	25	26	27	28	29	30	31	32	33	34	35	36	37	38	39		
Preli		,	Preliminary						,	Final value						,	Free Fall				
40	41	42	43	44	45	46	47	48	49	50	51	52	53								
,	High limit						,	Low limit												CR	LF

* Please input without the decimal point.

Appendix 3-> Command Mode 3 Description

CI-5000 : **Transmission only if data is requested (1 byte communication)**

Appendix 4-> ASCII Table

CHA	CODE	CHA	CODE	CHA	CODE	CHA	CODE	CHA	CODE	CHA	CODE
Space	32	0	48	@	64	P	80	`	96	p	112
!	33	1	49	A	65	Q	81	a	97	q	113
“	34	2	50	B	66	R	82	b	98	r	114
#	35	3	51	C	67	S	83	c	99	s	115
\$	36	4	52	D	68	T	84	d	100	t	116
%	37	5	53	E	69	U	85	e	101	u	117
&	38	6	54	F	70	V	86	f	102	v	118
‘	39	7	55	G	71	W	87	g	103	w	119
(40	8	56	H	72	X	88	h	104	x	120
)	41	9	57	I	73	Y	89	i	105	y	121
*	42	:	58	J	74	Z	90	j	106	z	122
+	43	;	59	K	75	[91	k	107	{	123
,	44	<	60	L	76	\	92	l	108		124
-	45	=	61	M	77]	93	m	109	}	125
.	46	>	62	N	78	^	94	n	110	~	126
/	47	?	63	O	79	_	95	o	111	End	255

MODBUS-RTU PROTOCOL

The MODBUS-RTU protocol enables to manage the reading and writing of the registers listed here below according to the specifications contained in the reference document for this standard **Modicon PI-MBUS-300**.

To select the communication with MODBUS-RTU, refer to paragraph **SERIAL COMMUNICATION SETTING**

When specifically indicated certain data will be written directly to EEPROM type memories. This memory has a limited number of writing operations (100.000), therefore unnecessary operations at said locations must be avoided. The instrument, in any case, ensures that no writing occurs if the value to be stored is equal to the stored value.

The numerical data listed below are expressed in decimal notation, or hexadecimal notation if preceded by 0x.

MODBUS-RTU DATA FORMAT

The data received and transmitted via MODBUS-RTU protocol have the following characteristics:

- 1 start bit
- 8 data bits, least significant bit sent first
- Instrument settable parity bit
- Instrument settable stop bit

MODBUS SUPPORTED FUNCTIONS

Among the commands available in the MODBUS-RTU protocol, only the following are used to manage communication with the instruments. Other commands may not be interpreted correctly and could generate errors or system shut-downs

FUNCTIONS	DESCRIPTION
03 (0x03)	READ HOLDING REGISTER (PROGRAMMABLE REGISTER READING)
16 (0x10)	PRESET MULTIPLE REGISTERS (MULTIPLE REGISTER WRITING)

The interrogation frequency is linked with the preset communication rate (the instrument will stand by for at least 3 bytes before beginning to calculate a possible response to the query).

The Delay parameter present in the paragraph **SERIAL COMMUNICATION SETTING** allows for a further delay in the instrument response, and this directly influences the number of possible queries in the unit of time.

For additional information on this protocol, refer to the general technical specification PI_MBUS_300.

In **general**, the query and response to and from a slave instrument are organised as follows:

FUNCTION 3: Read holding registers (PROGRAMMABLE REGISTER READING)

QUERY

Address	Funcion	Add. Register1	No. register	2 bytes
A	0x03	0x0000	0x0002	CRC

Tot. bytes = 8

RESPONSE

Address	Funcion	No.bytes	Register1	Register2	2 bytes
A	0x03	0x04	0x0064	0x00C8	CRC

Tot. bytes = 3 + 2*No. register+2

where: No. registers= number of Modbus register to be read, starting from the Address 1° register;

No. bytes = number of data bytes to follow;

FUNCTION 16: Preset multiple registers (MULTIPLE REGISTER WRITING)

QUERY

Addr	Func	Add. Reg.1	No.reg.	No. bytes	Val. Reg. 1	Val. Reg. 2	2 bytes
A	0x10	0x0000	0x0002	0x4	0x0000	0x0000	CRC

Tot. bytes = 7 + 2*No. register+2

RESPONSE

Address	Funcion	Add.Reg.1	No.reg.	2 bytes
A	0x10	0x0000	0x0002	CRC

Tot. bytes = 8

where: No. registers = number of Modbus register to be read, starting from the Address 1° register;
 No. bytes = number of data bytes to follow;
 Val.reg.1 = register contents beginning from the first.
 The Response contains the number of records changed starting from the Address 1° register.

COMMUNICATION ERROR MANAGEMENT

The communication strings are controlled by CRC (Cyclical Redundancy Check). In case of a communication error the slave will not respond with any string. The master must allow for a time-out before response reception. If no response is received it infers that a communication error has occurred.

In the event of a string received correctly but not executable, the slave responds with an EXCEPTIONAL RESPONSE. The "FUNCTION" field is transmitted with the msb at 1.

EXCEPTIONAL RESPONSE

Address	Function	Code	2bytes
A	Funct + 0x80		CRC

CODE	DESCRIPTION
1	ILLEGAL FUNCTION (Function not valid or not supported)
2	ILLEGAL DATA ADDRESS (The specified data address is not available)
3	ILLEGAL DATA VALUE (The data received have no valid value)
4	CRC Error

LIST OF USABLE REGISTERS

The MODBUS-RTU protocol implemented on this instrument can manage a maximum of 32 registers read and written in a single query or response.

R = the register can be read only

W = the register can be written only

R/W = the register can be both read and written

H = high half of the DOUBLE WORD forming the number

L = low half of the DOUBLE WORD forming the number

REGISTER	DESCRIPTION	Saving to EEPROM	ACCESS
4002	Type of instrument	-	R
4008	GROSS WEIGHT H	-	R
4009	GROSS WEIGHT L	-	R
4010	NET WEIGHT H	-	R
4011	NET WEIGHT L	-	R
4014	Raw AD Data_H	-	R
4015	Raw AD Data_L	-	R
4017	Set point 1 H	Y	R/W
4018	Set point 1 L	Y	R/W
4019	Set point 2 H	Y	R/W
4020	Set point 2 L	Y	R/W
4021	Set point 3 H	Y	R/W
4022	Set point 3 L	Y	R/W
4023	Set point 4 H	Y	R/W
4024	Set point 4 L	Y	R/W
4025	Set point 5 H	Y	R/W
4026	Set point 5 L	Y	R/W

40027	Set point 6 H	Y	R/W
40028	Set point 6 L	Y	R/W
40037	Ext_Input	-	R
40038	Ext_Output	-	R/W
40042	Analog out Span Weight H	Y	R/W
40043	Analog out Span Weight L	Y	R/W
40044	Analog out Zero Adjust H	Y	R/W
40045	Analog out Zero Adjust L	Y	R/W
40046	Analog out Span Adjust H	Y	R/W
40047	Analog out Span Adjust L	Y	R/W
40048	BCD Out Logic(Positive, Negative)	Y	R/W
40061	ADC Speed	Y	R/W
40062	AD Filter Size	Y	R/W

11. Error Message

11-1. Error Message from the Weight Setup Mode

Error	Cause	Solution
Err 20	The resolution was set in excess of the tolerance 1/10,000.	Lower the resolution. As the resolution = maximum tolerance / value of one division, adjust the resolution to 1/10,000 or less by correcting either the maximum allowable weight in CAL 1 or the value of one division in CAL3 in the weight setup mode.
Err 21	The resolution was set in excess of the tolerance 1/30,000.	Lower the resolution. As the resolution = maximum tolerance / value of one division, adjust the resolution to 1/30,000 or less by correcting either the maximum allowable weight in CAL 1 or the value of one division in CAL3 in the weight setup mode.
Err 22	The weight for the span adjustment was set to less than 10% of the maximum capacity.	Set the weight to 10% or more of the maximum capacity (set in CAL 1) from CAL 4 in the weight setup mode.
Err 23	The weight for the span adjustment was set to more than 100% of the maximum capacity.	Set the weight within the maximum capacity (set in CAL 1) from CAL 4 in the weight setup mode.
Err 24	Too low span.	Set the weight again by lowering the resolution as the setting of the current resolution is not possible because of either abnormality or lower output in the load cell. Too low weight for PCS and percent sample.
Err 25	Too high span.	There is either any abnormality or too high output in the load cell. Execute steps from the zeroing step in CAL 4 in the weight set up again. Too high weight for PCS and percent sample.
Err 26	Too high zero point.	Check whether or not the load tray is empty. Retry the weight setup after check at the test mode 3.
Err 27	Too low zero point.	Set the weight setting again after confirming what force is given to the load tray of the scale in the test mode 3.
Err 28	Weight is shaking.	Check the connection of the load cell connector.

11-2. Error Message from the Weighing Mode

Error	Cause	Solution
Err 01	The initialization of the scale cannot be done because of the shaking weight.	Turn on the power after placing the scale at a flat place with no vibration.
Err 02	Either the connection of load cell is wrong or there is abnormality in the A/D conversion section.	Check the connection between the load tray and the body.
Err 08	The zero key, tare key and start key were disabled at the instable weight.	Set the zero key, tare key and start key to the proper user conditions at F14 in the Set Mode.
Err 09	The current weight is out of the range of zero point.	Set the range of operations for the zero key to within 2% or 10% at F13 in the Set Mode.
Err 10	The tare to set is out of the maximum weight of the scale.	Set the tare to less than the maximum weight.
Err 12	The type of the configured printer is one that cannot support the total print.	DLP printers cannot make the total print. Set "F40" to '2' when DEP printers are used.
Err 13	The set value of zero point on the weight setting is out of range.	Check the status of the load tray and set the weight again.
Err 15	The range exceeded during setting the item code in the command mode.	Check the range of item code.
999999	The current weight on the load tray is too heavy and out of the allowable tolerance.	Avoid any weight in excess of the maximum allowable limit on the scale. If the load cell is damaged, it should be replaced.

MEMO



MEMO

CI-600A SERIES

Weighing Indicator



CAS BLDG., #1315, YANGJAE-DAERO,
GANGDONG-GU, SEOUL, KOREA

TEL_ 82 2 2225 3500

FAX_ 82 2 475 4668

www.globalcas.com